

ΚΛΙΜΑΤΙΣΤΙΚΑ ΣΥΣΤΗΜΑΤΑ S
A I R C O N D I T I O N I N G S Y S T E M S

Μοντέλα: A2MVI-09/A2MVO-09
A2MVI-12/A2MVO-12
A2MVI-18/A2MVO-18
A2MVI-24/A2MVO-24
P2MVI-09/P2MVO-09
P2MVI-12/P2MVO-12
P2MVI-18/P2MVO-12
P2MVI-24/P2MVO-24



Remote Controller Wall Mounted Unit
Owner's Manual

Ασύρματο Τηλεχειριστήριο
Επιτοίχιας Κλιματιστικής Μονάδας
Εγχειρίδιο Χρήσης

Σας ευχαριστούμε που επιλέξατε τη μονάδα κλιματισμού της INVENTOR. Για τη σωστή χρήση της μονάδας, παρακαλούμε διαβάστε προσεκτικά το παρόν εγχειρίδιο και φυλάξτε το για αναφορά στο μέλλον.

Thank you for choosing INVENTOR air conditioning system. For correct use of this unit, please read this manual carefully and keep it for future reference.

English/Ελληνικά/ Română



CONTENTS

Handling the remote controller	2
Remote controller Specifications.....	3
Function buttons	5
Indicators on LCD	8
How to use the buttons	9
Auto operation.....	9
Cooling/Heating/Fan operation.....	9
Dehumidifying operation	10
Adjusting air flow direction.....	10
Timer operation.....	11
SLEEP/FRESH function.....	14
LED/FOLLOW ME function	15
TRUBO/SELF CLEAN function	15

Handling the remote controller

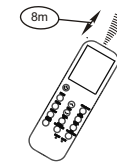
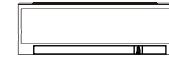

Location of the remote controller.

- Use the remote controller within a distance of 8 meters from the appliance, pointing it towards the receiver. Reception is confirmed by a beep.

CAUTIONS

- The air conditioner will not operate if curtains, doors or other materials block the signals from the remote controller to the indoor unit.
- Prevent any liquid from falling into the remote controller. Do not expose the remote controller to direct sunlight or heat.
- If the infrared signal receiver on the indoor unit is exposed to direct sunlight, the air conditioner may not function properly. Use curtains to prevent the sunlight from falling on the receiver.
- If other electrical appliances react to the remote controller. either move these appliances or consult your local dealer.

Replacing batteries

NOTE: Replace the batteries when there is no receiving beep from the indoor unit or if the transmission indicator on the remote controller fails to light.

The remote controller is powered by two dry batteries(R03/LR03X2) housed in the rear part and protected by a cover.

- (1) Remove the cover by pressing and sliding off.
- (2) Remove the old batteries and insert the new batteries,placing the(+) and (-) ends correctly.
- (3) Reattach the cover by sliding it back into position.

NOTE: When the batteries are removed, the remote controller erases all programming. After inserting new batteries, the remote controller must be reprogrammed.

CAUTIONS

- Do not mix old and new batteries or batteries of different types.
- Do not leave the batteries in the remote controller if they are not going to be used for 2 or 3 months.
- Do not dispose batteries as unsorted municipal waste. Collection of such waste separately for special treatment is necessary.

Remote Controller Specifications

Model	RG35A(2)/BG(C)EF, RG35A1(4)/BG(C)EF, RG35B/BG(C)E, RG35C/BG(C)E, RG36B3/BGE, RG36A(1)/BG(C)EF, RG36A2/BG(C)EF, RG36B(1)/BG(C)E, RG36C/BG(C)E
Rated Voltage	3.0V(Dry batteries R03/LR03 ×2)
Signal Receiving Range	8m
Environment	-5℃ ~60℃

Performance Feature

1. Operating Mode: AUTO, COOL, DRY, HEAT(Cooling only model without), and FAN.
2. Timer Setting Function in 24 hours.
3. Indoor Setting Temperature Range : 17℃~30℃.
4. Full function of LCD (Liquid Crystal Display).

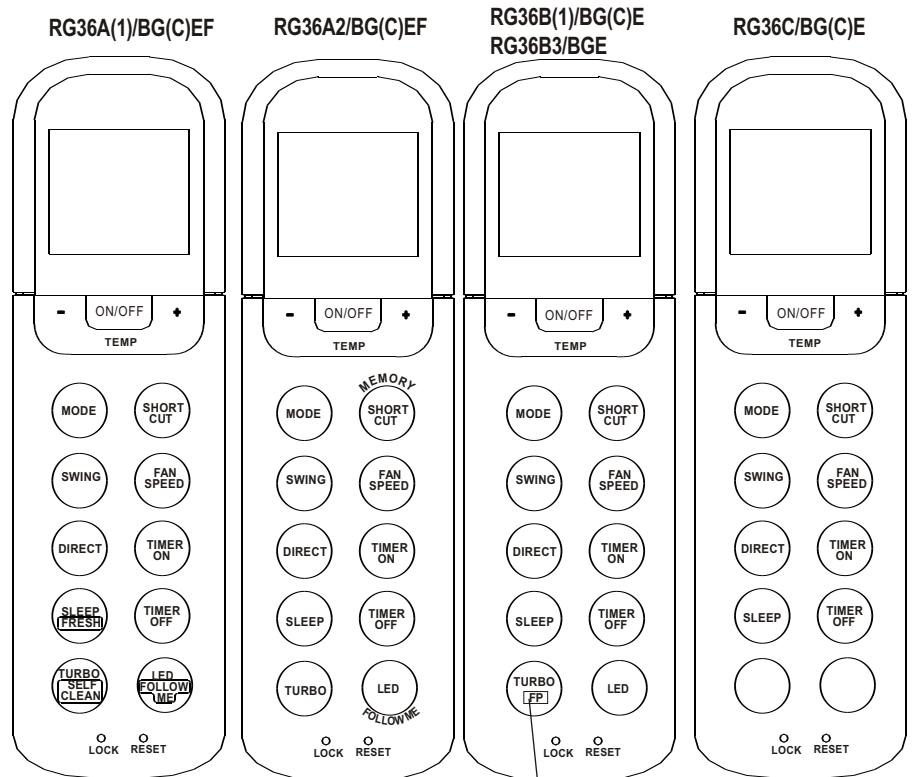
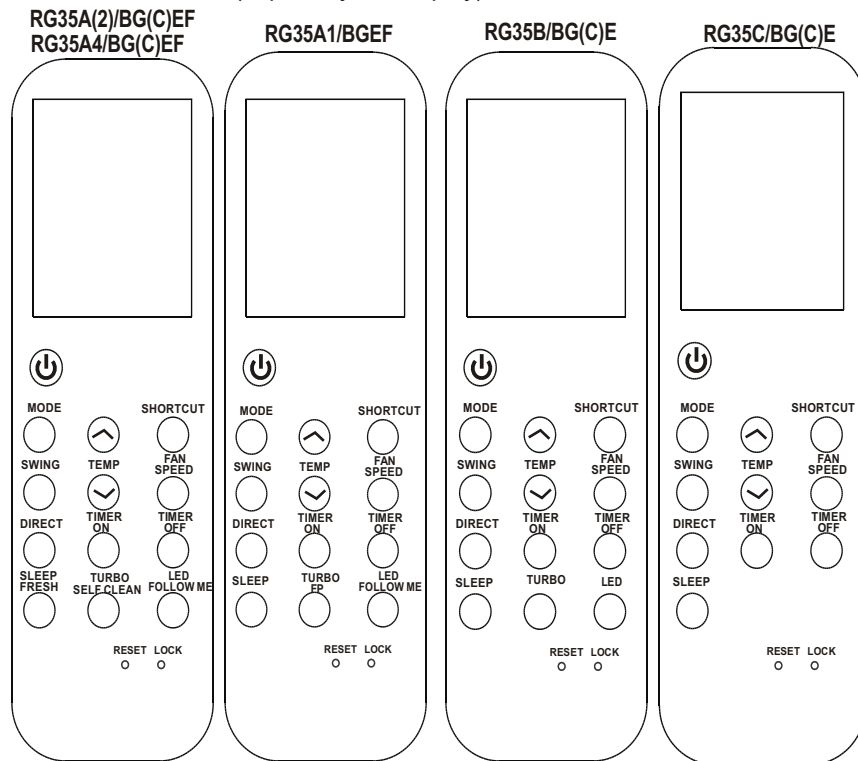

Modles of RG36B(3)/BG(C)E do not have FP function.

NOTE: There is only slight difference on the appearance between RG35 series and RG 36 series. The operations and functions of the buttons are the same. Some buttons have two functions, some buttons have only one function, for example: **SLEEP (FRESH)** and **SLEEP**. Please refer to the above

illustrations for details.

Function buttons

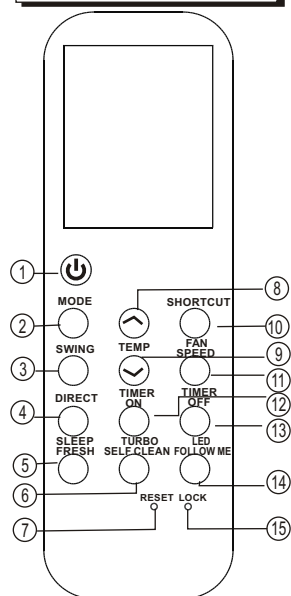

RG35A(2)

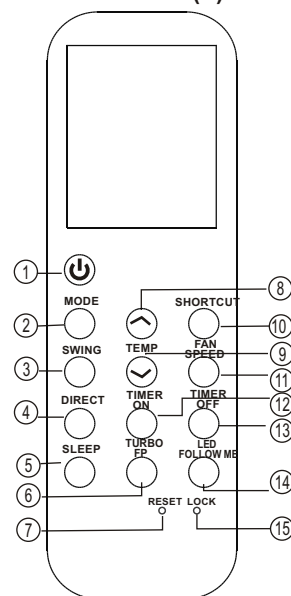

RG35A1

- ❶ **ON/OFF Button** (⏻ / ⏪)
Operation starts when this button is pressed and stops when this button is pressed again.
- ❷ **MODE Button**
Each time the button is pressed, the operation mode is selected in a sequence of the following:

AUTO	→	COOL	→	DRY	→	HEAT	→	FAN
------	---	------	---	-----	---	------	---	-----

NOTE: Heat mode is for Cooling & Heating models only.
- ❸ **SWING Button**
Used to stop or start horizontal louver auto swing feature.
- ❹ **DIRECT Button**
Used to change the louver movement and set the desired up/down air flow direction. The louver changes 6° in angle for each press.
- ❺ **SLEEP/FRESH Button**
Active/Disable SLEEP function. If pushing more than 2 seconds, the 'FRESH' function will be activated, pushing more than 2 seconds again to disable.
NOTE: While the unit is running under SLEEP mode, it would be cancelled if press the MODE, FAN SPEED or ON/OFF button.
- ❻ **TURBO/SELF CLEAN Button:**
 - Active/Disable TURBO function. If pushing more than 2 seconds, the 'SELF CLEAN' function will be activated, pushing more than 2 seconds again to disable (depending on models).
- ❼ **TURBO/FP Button:**
 - Active/Disable TURBO function. If pushing more than 2 seconds during the heating operation (only when the setting mode is HEAT), the unit will operate at high fan speed with the temperature automatically set to 8°C. The display window of indoor unit will display "FP". For the unit without display area, the defrost indicator light will be keeping on for 2 seconds, and then be off for 2 seconds by turns. Press ON/OFF, SLEEP, FP, MODE, FAN SPEED, UP, DOWN or SHORTCUT while operating will cancel the FP function.

5

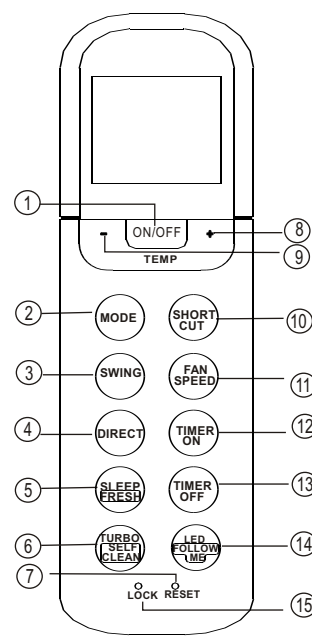

RG36A(1)

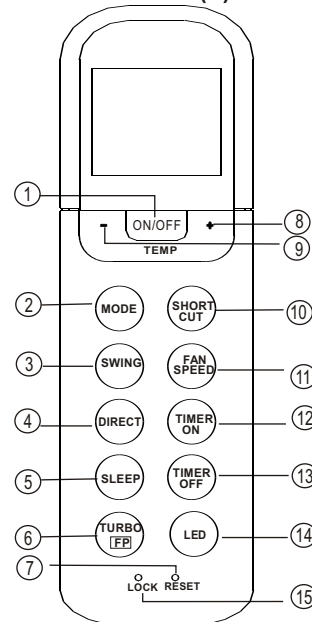

RG36B1

- ❼ **RESET Button:**
When you press the recessed RESET button, all current settings are cancelled and the control will return to the initial settings.
- ❽ **UP Button** (⤴ / +)
Push this button to increase setting temperature or to increase Hour during Timer setting.
- ❾ **DOWN Button** (⤵ / -)
Push this button to decrease setting temperature or to decrease Hour during Timer setting.
- ❿ **SHORTCUT(MEMORY SHORTCUT) Button**
 - Used to restore the current settings or resume previous settings.
 - On the first time connecting to the power, if push the SHORTCUT button, the unit will operate on AUTO mode, 24°C, and fan speed is Auto.
 - Push this button when remote controller is on, the system will automatically revert back to the previous settings including operating mode, setting temperature, fan speed level and sleep feature (if activated). And transmit the signals to the unit.
 - If push this button when remote controller is off, the system will only resume the previous settings and will not transmit the signals to the unit. And the sleep feature is disable.
 - If pushing more than 2 seconds, the system will automatically restore the current operation settings including operating mode, setting temperature, fan speed level and sleep feature (if activated).
- ⓫ **FAN SPEED Button**
Used to select the fan speed in four steps:

AUTO	→	LOW	→	MED	→	HIGH
------	---	-----	---	-----	---	------
- ⓬ **TIMER ON Button**
Press this button to initiate the auto-on time sequence. Each press will increase the auto-timed setting in 30 minutes increments. When the setting time displays 10H, each press will increase the auto-timed setting 60 minutes increments. To cancel the auto-timed program, simply adjust the auto-on time to 0.0.

6

Function buttons(continued)

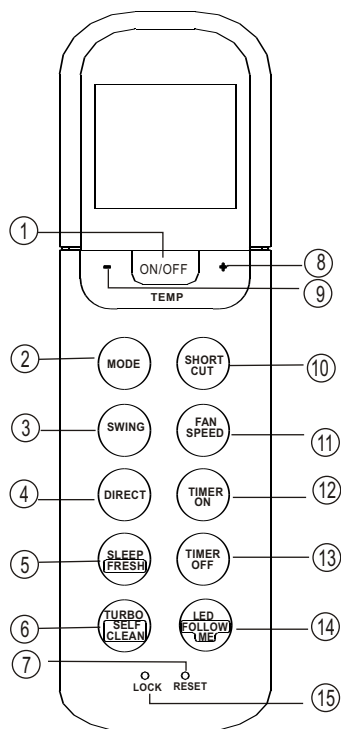

12 TIMER OFF Button

Press this button to initiate the auto-off time sequence. Each press will increase the auto-timed setting in 30 minutes increments. When the setting time displays 10H, each press will increase the auto-timed setting 60 minutes increments. To cancel the auto-timed program, simply adjust the auto-off time to 0.0

14 LED/FOLLOW ME Button

Disable/Active indoor screen Display. When pushing more than 2 seconds, the 'FOLLOW ME' function will be activated, pushing more than 2 seconds again to disable.

15 LOCK Button

When you press the recessed LOCK button, all current settings are locked in and the remote controller does not accept any operation except that of the LOCK. Press again to cancel the LOCK mode.

NOTE:

- Buttons design might be slightly different from the actual one you purchased depending on individual models.
- All the functions described above are accomplished by the indoor unit, if the indoor unit has no this feature, there is no corresponding operation happened when press the relative button on the remote controller.

Indicators on LCD

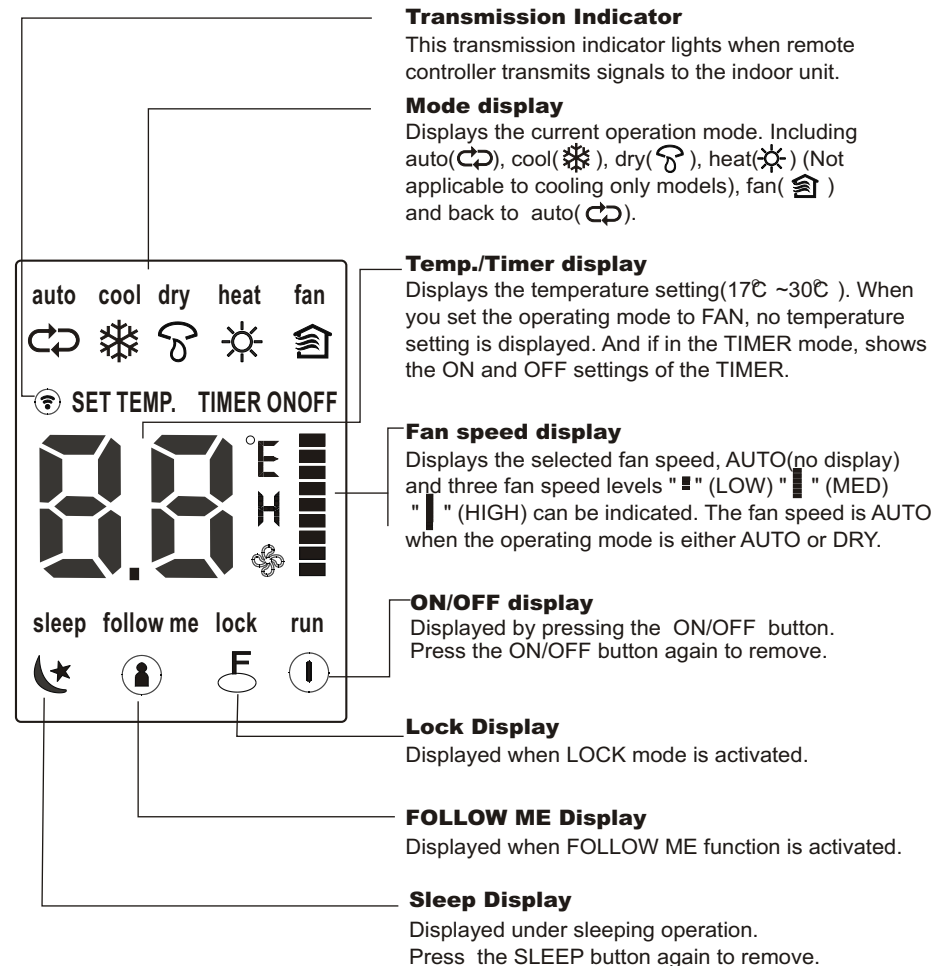

Note:

All indicators shown in the figure are for the purpose of clear presentation. But during the actual operation only the relative functional signs are shown on the display window.

How to use the buttons

Auto operation

Ensure the unit is plugged in and power is available. The OPERATION indicator on the display panel of the indoor unit starts flashing.

1. Press the **MODE** button to select Auto.
2. Press the **UP/DOWN** button to set the desired temperature. The temperature can be set within a range of 17°C~ 30°C in 1°C increments.
3. Press the **ON/OFF** button to start the air conditioner.

NOTE

1. In the Auto mode, the air conditioner can logically choose the mode of Cooling, Fan, and Heating by sensing the difference between the actual ambient room temperature and the setting temperature on the remote controller.
2. In the Auto mode, you can not switch the fan speed. It has already been automatically controlled.
3. If the Auto mode is not comfortable for you, the desired mode can be selected manually.

Cooling /Heating/Fan operation

Ensure the unit is plugged in and power is available.

1. Press the **MODE** button to select COOL, HEAT(cooling & heating models only) or FAN mode.
2. Press the **UP/DOWN** buttons to set the desired temperature. The temperature can be set within a range of 17°C~ 30°C in 1°C increments.
3. Press the **FAN** button to select the fan speed in four steps- Auto, Low, Med, or High.
4. Press the **ON/OFF** button to start the air conditioner.

NOTE

In the FAN mode, the setting temperature is not displayed in the remote controller and you are not able to control the room temperature either. In this case, only step 1, 3 and 4 may be performed.

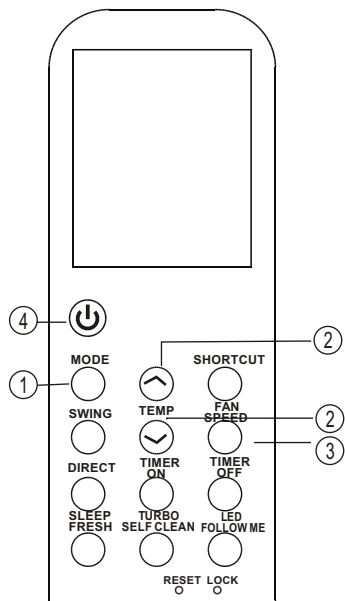
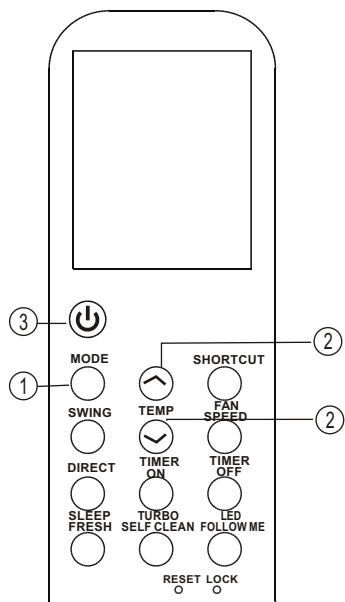

Dehumidifying operation

Ensure the unit is plugged in and power is available. The OPERATION indicator on the display panel of the indoor unit starts flashing.

1. Press the **MODE** button to select DRY mode.
2. Press the **UP/DOWN** buttons to set the desired temperature. The temperature can be set within a range of 17°C~ 30°C in 1°C increments.
3. Press the **ON/OFF** button to start the air conditioner.

NOTE

In the Dehumidifying mode, you can not switch the fan speed. It has already been automatically controlled.

Adjusting air flow direction

Use the SWING and DIRECT button to adjust the desired airflow direction.

1. When push the DIRECT button, the horizontal louver changes 6 degree in angle for each push.
2. When push the SWING button, the louver will swing up and down automatically.

NOTE: When the louver swing or move to a position which would affect the cooling or heating effect of the air conditioner, it would automatically change the swing/moving direction.

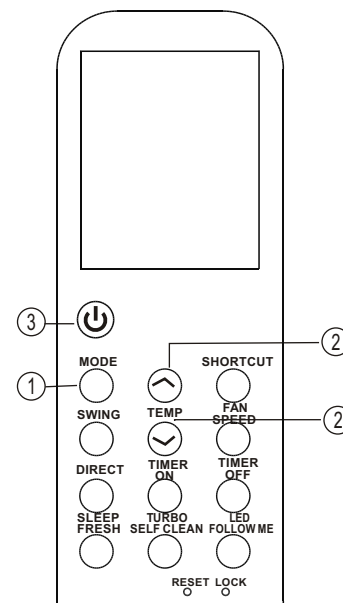

Timer operation

Press the TIMER ON button can set the auto-on time of the unit. Press the TIMER OFF button can set the auto-off time of the unit.

To set the Auto-on time.

1. Press the TIMER ON button. The remote controller shows TIMER ON, the last Auto-on setting time and the signal "h" will be shown on the LCD display area. Now it is ready to reset the Auto-on time to START the operation.
2. Push the TIMER ON button again to set desired Auto-on time. Each time you press the button, the time increases by half an hour between 0 and 10 hours and by one hour between 10 and 24 hours.
3. After setting the TIMER ON, there will be a one second delay before the remote controller transmits the signal to the air conditioner. Then, after approximately another 2 seconds, the signal "h" will disappear and the set temperature will re-appear on the LCD display window.

To set the Auto-off time.

1. Press the TIMER OFF button. The remote controller shows TIMER OFF, the last Auto-off setting time and the signal "h" will be shown on the LCD display area. Now it is ready to reset the Auto-off time to stop the operation.
2. Push the TIMER OFF button again to set desired Auto-off time. Each time you press the button, the time increases by half an hour between 0 and 10 hours and by one hour between 10 and 24 hours.
3. After setting the TIMER OFF, there will be a one second delay before the remote controller transmits the signal to the air conditioner. Then after approximately another 2 seconds, the signal "h" will disappear and the set temperature will re-appear on the LCD display window.

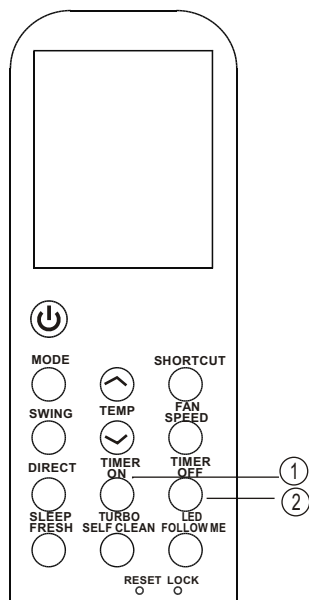

CAUTION

- The effective operation time set by the remote controller for the timer function is limited to the following settings: 0.5, 1.0, 1.5, 2.0, 2.5, 3.0, 3.5, 4.0, 4.5, 5.0, 5.5, 6.0, 6.5, 7.0, 7.5, 8.0, 8.5, 9.0, 9.5, 10, 11, 12, 13, 14, 15, 16, 17, 18, 19, 20, 21, 22, 23 and 24.

Example of timer setting

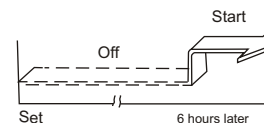

TIMER ON (Auto-on Operation)

The TIMER ON feature is useful when you want the unit to turn on automatically before you return home. The air conditioner will automatically start operating at the set time.

Example:

To start the air conditioner in 6 hours.

1. Press the TIMER ON button, the last setting of starting operation time and the signal "h" will show on the display area.
2. Press the TIMER ON button to display "6:0h" on the TIMER ON display of the remote controller.
3. Wait for 3 seconds and the digital display area will show the temperature again. The "TIMER ON" indicator remains on and this function is activated.

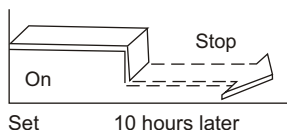

TIMER OFF (Auto-off Operation)

The TIMER OFF feature is useful when you want the unit to turn off automatically after you go to bed. The air conditioner will stop automatically at the set time.

Example:

To stop the air conditioner in 10 hours.

1. Press the TIMER OFF button, the last setting of stopping operation time and the signal "h" will show on the display area.
2. Press the TIMER OFF button to display "10h" on the TIMER OFF display of the remote controller.
3. Wait for 3 seconds and the digital display area will show the temperature again. The "TIMER OFF" indicator remains on and this function is activated.

COMBINED TIMER

(Setting both ON and OFF timers simultaneously)

TIMER OFF → TIMER ON

(On → Stop → Start operation)

This feature is useful when you want to stop the air conditioner after you go to bed, and start it again in the morning when you wake up or when you return home.

Example:

To stop the air conditioner 2 hours after setting and start it again 10 hours after setting.

1. Press the TIMER OFF button.
2. Press the TIMER OFF button again to display 2.0h on the TIMER OFF display.
3. Press the TIMER ON button.
4. Press the TIMER ON button again to display 10h on the TIMER ON display .
5. Wait for 3 seconds and the digital display area will show the temperature again. The "TIMER ON OFF" indicator remains on and this function is activated.

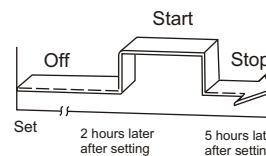
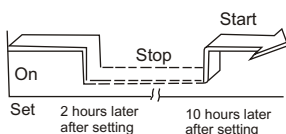

TIMER ON → TIMER OFF (Off → Start → Stop operation)

This feature is useful when you want to start the air conditioner before you wake up and stop it after you leave the house.

Example:

To start the air conditioner 2 hours after setting, and stop it 5 hours after setting.

1. Press the TIMER ON button.
2. Press the TIMER ON button again to display 2.0h on the TIMER ON display.
3. Press the TIMER OFF button.
4. Press the TIMER OFF button again to display 5.0h on the TIMER OFF display .
5. Wait for 3 seconds and the digital display area will show the temperature again. The "TIMER ON OFF" indicator remains on and this function is activated.

NOTE: The timer setting(TIMER ON or TIMER OFF) that in sequence occurs directly after the set time will be activated first.

SLEEP/FRESH function

- Press this button less than 2nds will initiate SLEEP function. And if keep pressing this button more than 2nds,the FRESH function is initiated.
- The sleep function enables the unit to automatically increase(cooling) or decrease(heating) 1°C per hour for the first two hours, then hold steady for the next 5 hours, after that the unit will stop operation. It can maintain the most comfortable temperature and save energy.
NOTE: The SLEEP function is only available under Cooling, Heating and AUTO operations.
- When the FRESH function is initiated, the Ionizer/Plasma Dust Collector(dependent on models) is energized and will help to remove pollen and impurities from the air.

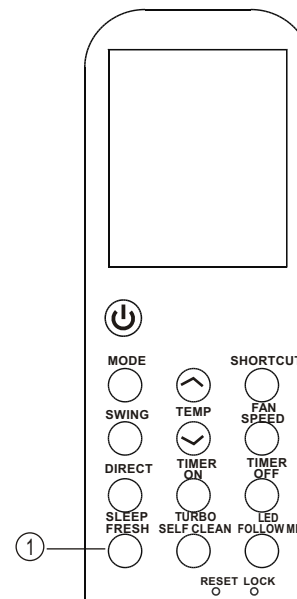

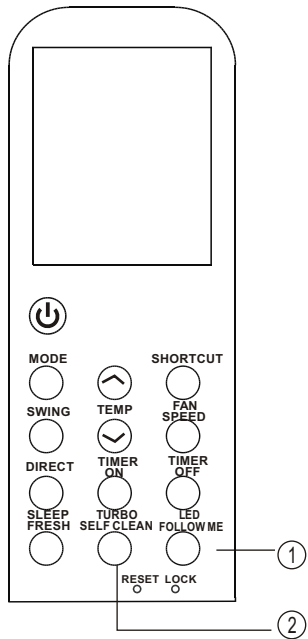

LED/FOLLOW ME function

- Press this button less than 2nds will initiate LED function. And if keep pressing this button more than 2nds, the FOLLOW ME function is initiated.
- When the Follow Me function is activated, the remote display is actual temperature at its location. The remote control will send this signal to the air conditioner every 3 minutes interval until press the FOLLOW ME button again.
- The Follow Me function is not available under DRY and FAN mode.
- Switch the operation mode or turn off the unit will cancel the Follow Me function automatically.

TURBO/SELF CLEAN function

- Press this button less than 2nds will initiate TURBO function. And if keep pressing this button more than 2nds, the SELF CLEAN function is initiated.
- Turbo function enables the unit to reach the preset temperature in the shortest time. When press this button on cooling mode, the unit will blow strong cooling air with super high fan speed. When press this button on heating mode (applicable to the unit adopts PTC only), the PTC will be energized and bring fast heating operation.
- Under SELF CLEAN mode, the air conditioner will automatically clean and dry the Evaporator and keep it as fresh for the next operation.

ΠΕΡΙΕΧΟΜΕΝΑ

Χειρισμός του Ασύρματου Τηλεχειριστηρίου	2
Χαρακτηριστικά του Ασύρματου Τηλεχειριστηρίου	3
Λειτουργίες Πλήκτρων	5
Ενδείξεις στην LCD Οθόνη	8
Χρήση των πλήκτρων	9
Αυτόματη Λειτουργία.....	9
Λειτουργίες Ψύξης/Θέρμανσης/Ανεμιστήρα	9
Λειτουργία Αφύγρανσης	10
Ρύθμιση της ροής του αέρα	10
Λειτουργία Timer	11
Λειτουργία SLEEP/FRESH	14
Λειτουργία LED/FOLLOW ME	15
Λειτουργία TURBO/SELF CLEAN	15

Χειρισμός του Ασύρματου Τηλεχειριστηρίου

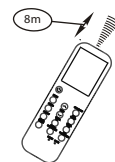
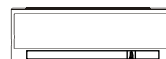

Θέση του Ασύρματου Τηλεχειριστηρίου

- Να χρησιμοποιείτε το ασύρματο τηλεχειριστήριο εντός 8m από την κλιματιστική μονάδα στοχεύοντας στον δέκτη σήματος. Η αποδοχή της εντολής συνοδεύεται από ένα ήχο.

▲ ΠΡΟΦΥΛΑΞΕΙΣ

- Η κλιματιστική μονάδα δεν θα λειτουργεί αν εμποδίζονται οι εντολές του ασύρματου τηλεχειριστηρίου προς την εσωτερική μονάδα από κουρτίνες, πόρτες ή άλλα αντικείμενα
- Αποφύγετε την εισροή νερού στο ασύρματο τηλεχειριστήριο. Βεβαιωθείτε πως δεν είναι εκτεθειμένο σε ηλιακή ακτινοβολία ή σε πηγή θερμότητας.
- Εάν ο υπέρυθρος δέκτης εντολής της εσωτερικής μονάδας είναι εκτεθειμένος στην ηλιακή ακτινοβολία, η κλιματιστική μονάδα μπορεί να μην λειτουργεί σωστά. Χρησιμοποιήστε τις κουρτίνες για να αποφύγετε την απευθείας ηλιακή ακτινοβολία στον δέκτη της μονάδας.
- Εάν άλλες συσκευές επηρεάζουν τη λειτουργία του ασύρματου τηλεχειριστηρίου, απομακρύνετε αυτές τις συσκευές ή συμβουλευτείτε τον προμηθευτή σας.

Αντικατάσταση μπαταριών

ΣΗΜΕΙΩΣΗ: Αντικαταστήστε τις μπαταρίες όταν δεν ακούτε τον αντίστοιχο ήχο από την εσωτερική μονάδα ή όταν η ένδειξη εντολής στο ασύρματο τηλεχειριστήριο δεν ανάβει. Το ασύρματο τηλεχειριστήριο χρειάζεται 2 ξηρού τύπου μπαταρίες(R03/LR03X2) που βρίσκονται στην πίσω πλευρά του.

- (1) Αφαιρέστε το κάλυμα.
- (2) Αφαιρέστε τις παλιές μπαταρίες και τοποθετήστε τις νέες με σωστή φορά των άκρων (+) και (-).
- (3) Επανατοποθετήστε το κάλυμα.

ΣΗΜΕΙΩΣΗ: Όταν αφαιρούνται οι μπαταρίες διαγράφονται όλες οι ρυθμίσεις που είχαν γίνει στο ασύρματο τηλεχειριστήριο. Αφού τοποθετηθούν οι νέες μπαταρίες θα πρέπει να γίνει επαναπρογραμματισμός του ασύρματου τηλεχειριστηρίου.

▲ ΠΡΟΣΟΧΗ

- Μην τοποθετείτε τις παλιές μπαταρίες μαζί με τις νέες ή με άλλου τύπου. Εάν δεν πρόκειται να χρησιμοποιήσετε το ασύρματο τηλεχειριστήριο για 2 με 3 μήνες να αφαιρέτε τις μπαταρίες.
- Να απορρίπτετε τις παλιές μπαταρίες σε ειδικά δοχεία που υπάρχουν σε καταστήματα.

Χαρακτηριστικά Ασύρματου Τηλεχειριστηρίου

Μοντέλο	RG35A(2)/BG(C)EF, RG35A1(4)/BG(C)EF, RG35B/BG(C)E, RG35C/BG(C)E, RG36B3/BGE, RG36A(1)/BG(C)EF, RG36A2/BG(C)EF, RG36B(1)/BG(C)E, RG36C/BG(C)E
Τάση	3.0V(Dry batteries R03/LR03 ×2)
Εύρος μετάδοσης σήματος	8m
Θερμοκρασία περιβάλλοντος	-5 °C ~ 60 °C

Χαρακτηριστικά λειτουργίας

- Κατάσταση λειτουργίας: AUTO (Αυτόματη), COOL (Ψύξη), DRY (Αφύγνωση), HEAT (Θέρμανση) (μόνο για τα μοντέλα τύπου αντλίας θερμότητας) και FAN (Ανεμιστήρας).
- Λειτουργία ρύθμισης Timer (χρονοδιακόπτη) σε 24 ώρες.
- Εύρος ρύθμισης θερμοκρασίας.
- Πλήρης λειτουργία της LCD οθόνης.

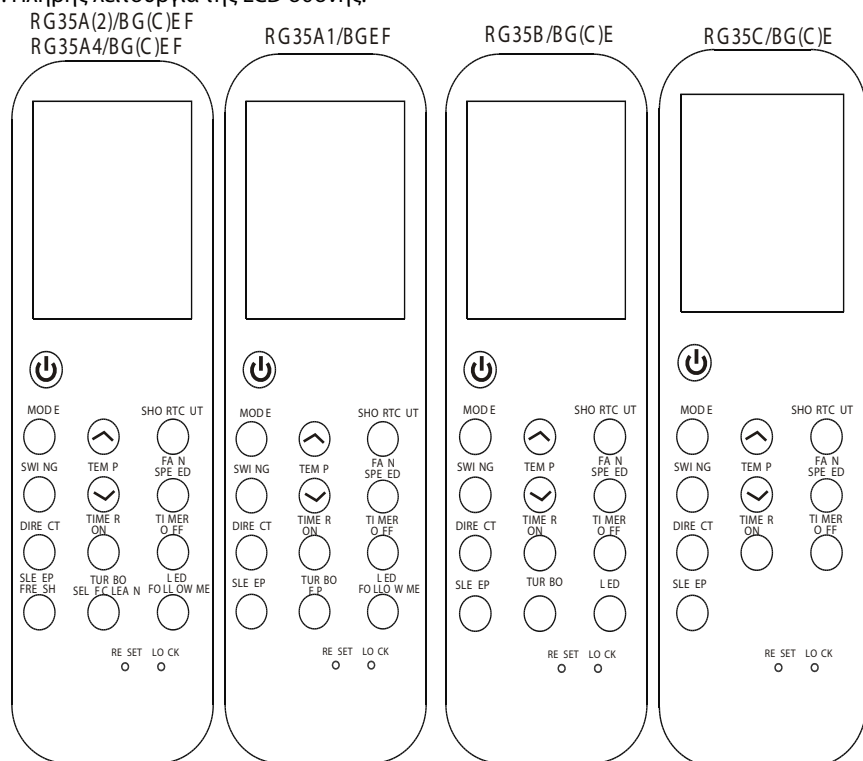

3

RG36A(1)/BG(C)EF

RG36A2/BG(C)EF

RG36B(1)/BG(C)E
RG36B3/BGE

RG36C/BG(C)E

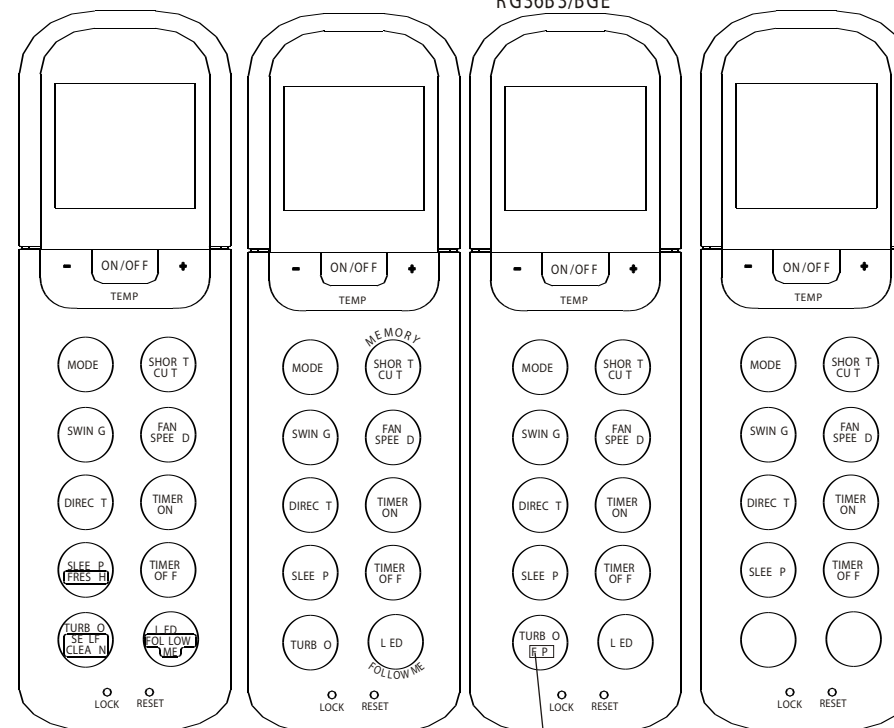

Τα μοντέλα RG36B/BG(C)E δεν διαθέτουν τη λειτουργία FP

ΣΗΜΕΙΩΣΗ: Υπάρχει μόνο μια μικρή διαφορά μεταξύ των RG35 και RG36. Οι λειτουργίες των πλήκτρων είναι ίδιες. Ορισμένα πλήκτρα έχουν δύο λειτουργίες, ορισμένα πλήκτρα έχουν μία λειτουργία.

Για παράδειγμα:  και 

Ανατρέξτε στις παραπάνω εικόνες για λεπτομέρειες.

4

Λειτουργίες Πλήκτρων

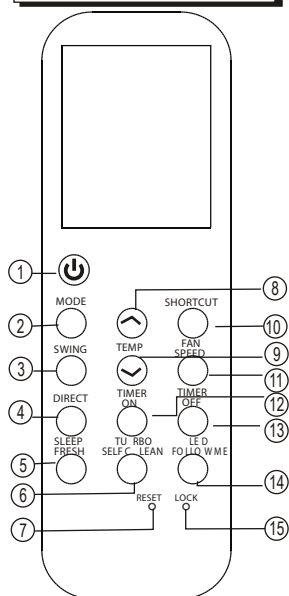

RG35A(2)

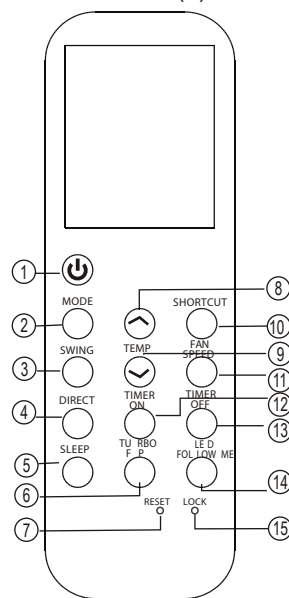

RG35A1

- Πλήκτρο ON/OFF** /
 Με αυτό το πλήκτρο γίνεται η εκκίνηση και η διακοπή της λειτουργίας της κλιματιστικής μονάδας.
- Πλήκτρο MODE**
 Κάθε φορά που πιάζετε το συγκεκριμένο πλήκτρο, η κατάσταση λειτουργίας θα αλλάζει σύμφωνα με την παρακάτω σειρά:

AUTO	COOL	DRY	HEAT	FAN
(Αυτόματη)	(Ψύξη)	(Αφύγρανση)	(Θέρμανση)	(Ανεμιστήρας)

ΣΗΜΕΙΩΣΗ: Η λειτουργία θέρμανσης υπάρχει μόνο στις μονάδες τύπου αντίλα θερμότητας.

- Πλήκτρο SWING**
 Με αυτό το πλήκτρο επιλέγετε την εκκίνηση ή διακοπή της κίνησης της κάθετης περσίδας.
- Πλήκτρο DIRECT**
 Με αυτό το πλήκτρο μπορείτε να αλλάξετε την κίνηση της περσίδας και να ορίσετε την επιθυμητή κατεύθυνση της ροής του αέρα πάνω/κάτω. Κάθε φορά που πιάζετε το συγκεκριμένο πλήκτρο η γωνία της περσίδας αλλάζει κατά 6 μοίρες.
- Πλήκτρο SLEEP/FRESH**
 Ενεργοποίηση/Απενεργοποίηση της λειτουργίας SLEEP. Αν πιάσετε το πλήκτρο πάνω από 2 δευτερόλεπτα θα ενεργοποιηθεί η λειτουργία FRESH. Αν το πιάσετε άλλη μια φορά πάνω από 2 δευτερόλεπτα η λειτουργία θα απενεργοποιηθεί.
 ΣΗΜΕΙΩΣΗ: Όταν η μονάδα λειτουργεί σε κατάσταση SLEEP αν πιάσετε τα πλήκτρα MODE, FAN SPEED ή ON/OFF η λειτουργία θα απενεργοποιηθεί.

- Πλήκτρο TURBO/SELF CLEAN:**
 Ενεργοποίηση/Απενεργοποίηση της λειτουργίας TURBO. Αν πιάσετε το πλήκτρο πάνω από 2 δευτερόλεπτα θα ενεργοποιηθεί η λειτουργία SELF CLEAN. Αν το πιάσετε άλλη μια φορά πάνω από 2 δευτερόλεπτα η λειτουργία θα απενεργοποιηθεί (ανάλογα το μοντέλο).
- Πλήκτρο TURBO/FP:**
 Ενεργοποίηση/Απενεργοποίηση της λειτουργίας TURBO. Εάν κατά τη λειτουργία της μονάδας σε θέρμανση πιάσετε το συγκεκριμένο πλήκτρο πάνω από 2 δευτερόλεπτα (μόνο όταν έχετε επιλέξει λειτουργία ΘΕΡΜΑΝΣΗΣ), μονάδα θα λειτουργήσει στην υψηλή ταχύτητα και η θερμοκρασία θα οριστεί αυτόματα στους 8°C. Στην οθόνη της εσωτερικής μονάδας θα εμφανιστεί η ένδειξη FP. Στις μονάδες χωρίς οθόνη η ενδεικτική λυχνία αποπύκνωσης θα αναβοσβήνει για 2 δευτερόλεπτα και θα σβήνει για 2 δευτερόλεπτα. Αν πιάσετε κάποιο από τα πλήκτρα ON/OFF, SLEEP, FP, MODE, FAN SPEED, UP, DOWN ή SHORTCUT η λειτουργία θα ακυρωθεί.

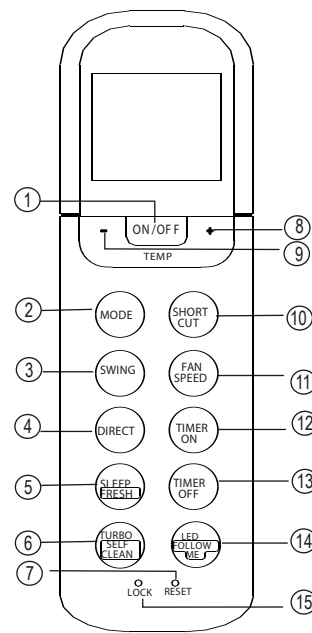

RG36A(1)

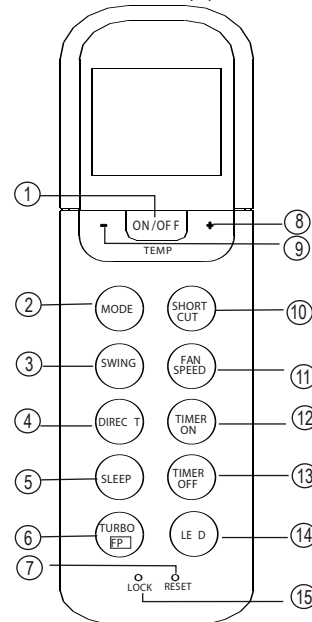

RG36B1

- Πλήκτρο RESET**
 Εάν πιάσετε αυτό το πλήκτρο θα ακυρωθούν όλες οι ρυθμίσεις που έχουν γίνει και το ασύρματο τηλεχειριστήριο θα επιστρέψει στις αρχικές του ρυθμίσεις.
- Πλήκτρο UP** (/)
 Πιάστε αυτό το πλήκτρο για να αυξήσετε την θερμοκρασία ή να αυξήσετε την ώρα κατά τη ρύθιση του Timer.
- Πλήκτρο DOWN** (/)
 Πιάστε αυτό το πλήκτρο για να μειώσετε την θερμοκρασία ή να μειώσετε την ώρα κατά τη ρύθιση του Timer.
- Πλήκτρο SHORTCUT(MEMORY SHORTCUT)**
 • Με αυτό το πλήκτρο μπορείτε να επαναφέρετε τις τρέχουσες ρυθμίσεις ή να επαναλάβετε προηγούμενες ρυθμίσεις.
 • Κατά την πρώτη ενεργοποίηση της μονάδας, εάν πιάσετε το πλήκτρο SHORTCUT η μονάδα θα λειτουργήσει σε κατάσταση AUTO, στους 24C και η ταχύτητα του ανεμιστήρα θα είναι αυτόματη.
 • Όταν πιάσετε αυτό το πλήκτρο η μονάδα θα επανέλθει αυτόματα στις προηγούμενες ρυθμίσεις συμπεριλαμβανομένων την επιλεγμένη θερμοκρασία, την ταχύτητα του ανεμιστήρα και την λειτουργία SLEEP (αν είναι ενεργοποιημένη). Θα ακουστεί ο ήχος μεταφοράς της εντολής.
 • Αν πιάσετε το συγκεκριμένο πλήκτρο ενώ η μονάδα είναι απενεργοποιημένη, θα επανέλθουν οι προηγούμενες ρυθμίσεις αλλά δεν θα δοθεί εντολή στη μονάδα. Η λειτουργία SLEEP είναι απενεργοποιημένη.
 • Εάν πιάσετε το συγκεκριμένο πλήκτρο για 2 δευτερόλεπτα, η μονάδα θα επανέλθει αυτόματα στις τρέχουσες ρυθμίσεις συμπεριλαμβανομένων της επιλεγμένης θερμοκρασίας, την ταχύτητα του ανεμιστήρα και τη λειτουργία SLEEP (εάν είναι ενεργοποιημένη).
- Πλήκτρο FAN SPEED**
 Με αυτό το πλήκτρο μπορείτε να επιλέξετε την ταχύτητα του ανεμιστήρα όπως παρακάτω:

Auto	Low	Med	High
(Αυτόματη)	(Χαμηλή)	(Μεσαία)	(Υψηλή)
- Πλήκτρο TIMER ON**
 Πιάστε αυτό το πλήκτρο για να ενεργοποιήσετε την ρύθμιση της αυτόματης ενεργοποίησης. Κάθε φορά που πιάζετε αυτό το πλήκτρο η ρύθμιση της ώρας αυξάνεται κατά μισή ώρα έως τις 10 ώρες και κατά 1 ώρα έως τις 24 ώρες. Για να ακυρώσετε τη ρύθμιση, πιάστε το πλήκτρο μέχρι η ένδειξη της ώρας να γίνει 0.0.

Λειτουργίες Πλήκτρων

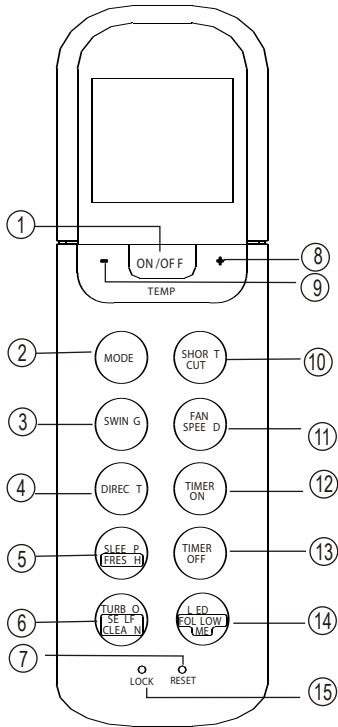





- 13** Πλήκτρο TIMER OFF
Πιέστε αυτό το πλήκτρο για να ενεργοποιήσετε την ρύθμιση της αυτόματης απενεργοποίησης. Κάθε φορά που πιέζετε αυτό το πλήκτρο η ρύθμιση της ώρας αυξάνεται κατά μισή ώρα έως τις 10 ώρες και κατά 1 ώρα έως τις 24 ώρες. Για να ακυρώσετε τη ρύθμιση, πιέστε το πλήκτρο μέχρι η ένδειξη της ώρας να γίνει 0.0.
- 14** Πλήκτρο LED/FOLLOW ME
Ενεργοποίηση/Απενεργοποίηση της Οθόνης. Όταν πιέσετε το πλήκτρο για 2 δευτερόλεπτα θα ενεργοποιηθεί η λειτουργία FOLLOW ME. Αν το πιέσετε άλλη μια φορά για 2 δευτερόλεπτα η λειτουργία θα ακυρωθεί.
- 15** Πλήκτρο LOCK
Πιέστε αυτό το πλήκτρο για να κλειδώσετε όλες τις ρυθμίσεις και το ασύρματο τηλεχειριστήριο δεν θα δέχεται καμία εντολή εκτός από αυτή του LOCK. Χρησιμοποιήστε αυτό το πλήκτρο εάν θέλετε να αποφύγετε τυχαία αλλαγή των ρυθμίσεων. Όταν έχετε ενεργοποιήσει την λειτουργία LOCK θα εμφανίζεται στην οθόνη του ασύρματου τηλεχειριστηρίου η ένδειξη κλειδώματος.

ΣΗΜΕΙΩΣΗ:



- Τα πλήκτρα που εμφανίζονται στο παρόν εγχειρίδιο μπορεί να διαφέρουν από αυτά που υπάρχουν στο τηλεχειριστήριο που έχετε προμηθευτεί.
- Οι παραπάνω λειτουργίες που περιγράφονται μπορεί να μην ισχύουν σε όλα τα μοντέλα. Εάν η εσωτερική μονάδα δεν υποστηρίζει κάποια λειτουργία, ακόμα και αν πιέσετε το αντίστοιχο πλήκτρο δεν θα ενεργοποιηθεί κάποια εντολή.

Ενδείξεις στην LCD οθόνη

Ένδειξη μετάδοσης εντολής
Αυτή η ένδειξη θα ανάβει όταν το σύρματο τηλεχειριστήριο δίνει εντολή στην εσωτερική μονάδα.

Ένδειξη κατάστασης λειτουργίας
Εμφανίζεται η επιλεγμένη κατάσταση λειτουργίας, AUTO (Αυτόματη) , COOL (Ψύξη) , DRY (Αφύγραση) , HEAT (Θέρμανση)  και FAN (Ανεμιστήρας) .

Ένδειξη θερμοκρασίας/timer
Εμφανίζεται είτε η επιλογή της θερμοκρασίας (από 17°C έως 30°C) είτε η ρύθμιση του TIMER ON ή TIMER OFF. Εάν έχετε επιλέξει τη λειτουργία FAN δεν θα εμφανίζεται κάποια ένδειξη.

Ένδειξη ταχύτητας ανεμιστήρα
Εμφανίζεται η επιλεγμένη ταχύτητα ανεμιστήρα: AUTO (Αυτόματη), HIGH (Υψηλή) , MED (Μεσαία)  (εάν υπάρχει διαθέσιμη) και LOW (Χαμηλή) . Εάν έχει επιλεγεί η αυτόματη ταχύτητα δεν θα εμφανίζεται κάποια ένδειξη. Κατά τις λειτουργίες AUTO ή DRY δεν θα εμφανίζεται κάποια ένδειξη.

Ένδειξη ON/OFF
Αυτή η ένδειξη θα εμφανίζεται όταν η μονάδα βρίσκεται σε λειτουργία.

Ένδειξη LOCK
Η ένδειξη LOCK εμφανίζεται όταν πιέσετε το αντίστοιχο πλήκτρο. Αν πιέσετε άλλη μια φορά το ίδιο πλήκτρο η ένδειξη θα σβηστεί από την οθόνη.

Ένδειξη FOLLOW ME
Η ένδειξη FOLLOW ME εμφανίζεται όταν έχει ενεργοποιηθεί η συγκεκριμένη λειτουργία

Ένδειξη SLEEP
Η συγκεκριμένη ένδειξη εμφανίζεται όταν έχει ενεργοποιηθεί η συγκεκριμένη λειτουργία. Αν πιέσετε άλλη μια φορά το συγκεκριμένο πλήκτρο η ένδειξη θα απενεργοποιηθεί.

Σημείωση:

Οι ενδείξεις που περιγράφονται στο παρόν εγχειρίδιο είναι αναφορικές. Κατά την πραγματική λειτουργία στην οθόνη θα εμφανίζονται οι πραγματικές ενδείξεις.

Χρήση των πλήκτρων

Αυτόματη λειτουργία (Auto)

Βεβαιωθείτε πως η κλιματιστική μονάδα είναι συνδεδεμένη με την παροχή ρεύματος. Η ενδεικτική λυχνία OPERATION (λειτουργίας) στην οθόνη της εσωτερικής μονάδας είναι αναμμένη.

1. Πιέστε το πλήκτρο MODE και επιλέξτε Auto.
2. Πιέστε το πλήκτρο TEMP για να ορίσετε την επιθυμητή θερμοκρασία. Η θερμοκρασία μπορεί να ρυθμιστεί εντός του εύρους 17°C-30°C με αύξηση κατά 1°C.
3. Πιέστε το πλήκτρο ON/OFF για να ξεκινήσει η λειτουργία της κλιματιστικής μονάδας.

ΣΗΜΕΙΩΣΗ

1. Όταν έχετε επιλέξει την κατάσταση Auto, η κλιματιστική μονάδα επιλέγει αυτόματα λειτουργία ψύξης, θέρμανσης, ανεμιστήρα και αφύγρανσης ανάλογα με τη διαφορά θερμοκρασίας μεταξύ της θερμοκρασίας χώρου και της επιλεγμένης θερμοκρασίας.
2. Κατά την λειτουργία Auto δεν μπορείτε να επιλέξετε την ταχύτητα του ανεμιστήρα, έχει επιλεγεί αυτόματα.
3. Εάν η λειτουργία Auto δεν είναι η κατάλληλη για εσάς, μπορείτε να επιλέξετε χειροκίνητα την επιθυμητή κατάσταση λειτουργίας.

Λειτουργίες Ψύξης/Θέρμανσης/Ανεμιστήρα

Βεβαιωθείτε πως η κλιματιστική μονάδα είναι συνδεδεμένη με την παροχή ρεύματος.

1. Πιέστε το πλήκτρο MODE για να επιλέξετε τη λειτουργία ψύξης, θέρμανσης ή ανεμιστήρα.
2. Πιέστε το πλήκτρο TEMP για να ορίσετε την επιθυμητή θερμοκρασία. Η θερμοκρασία μπορεί να ρυθμιστεί εντός του εύρους 17°C-30°C με αύξηση κατά 1°C.
3. Πιέστε το πλήκτρο FAN SPEED για να επιλέξετε την ταχύτητα του ανεμιστήρα.
4. Πιέστε το πλήκτρο ON/OFF για να ξεκινήσει η λειτουργία της κλιματιστικής μονάδας.

ΣΗΜΕΙΩΣΗ

Κατά τη λειτουργία FAN(ανεμιστήρας), δεν θα εμφανίζεται στο ασύρματο τηλεχειριστήριο η επιλεγμένη θερμοκρασία και δεν θα μπορείτε να ελέγξετε τη θερμοκρασία του χώρου. Σε αυτή την περίπτωση μπορείτε να ακολουθήσετε τα βήματα 1,3 και 4.

Λειτουργία Αφύγρανσης

Βεβαιωθείτε πως η κλιματιστική μονάδα είναι συνδεδεμένη με την παροχή ρεύματος. Η ενδεικτική λυχνία OPERATION (λειτουργίας) στην οθόνη της εσωτερικής μονάδας θα είναι αναμμένη.

1. Πιέστε το πλήκτρο MODE για να επιλέξετε την λειτουργία DRY.
2. Πιέστε το πλήκτρο TEMP για να επιλέξετε την επιθυμητή θερμοκρασία. Η θερμοκρασία μπορεί να ρυθμιστεί εντός του εύρους 17°C-30°C με αύξηση κατά 1°C.
3. Πιέστε το πλήκτρο ON/OFF για να ξεκινήσει η λειτουργία της κλιματιστικής μονάδας.

ΣΗΜΕΙΩΣΗ

Κατά τη λειτουργία αφύγρανσης, δεν μπορείτε να επιλέξετε ταχύτητα ανεμιστήρα. Έχει επιλεγεί αυτόματα.

Ρύθμιση της κατεύθυνσης της ροής του αέρα

Χρησιμοποιήστε τα πλήκτρα DIRECT και SWING για να ορίσετε την επιθυμητή κατεύθυνση της ροής του αέρα.

1. Κάθε φορά που πιέζετε το πλήκτρο DIRECT η γωνία της οριζόντιας περσίδας αλλάζει κατά 6 μοίρες.
2. Όταν πιέσετε το πλήκτρο SWING, η περσίδα θα αρχίσει να κινείται αυτόματα

ΣΗΜΕΙΩΣΗ: Όταν η κίνηση των περσίδων ή όταν επιλογή μιας θέσης επηρεάζει την ψυκτική και θερμική απόδοση της κλιματιστικής μονάδας, τότε η ίδια η μονάδα θα αλλάξει αυτόματα την κατεύθυνση της ροής του αέρα.

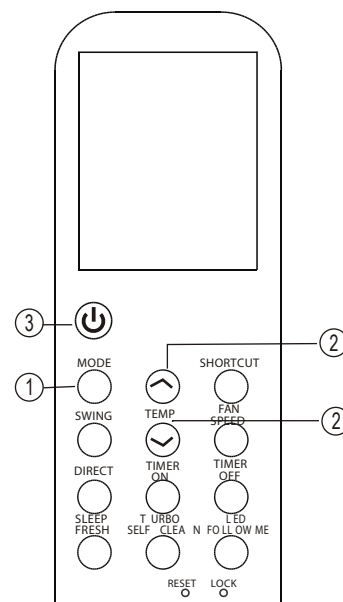
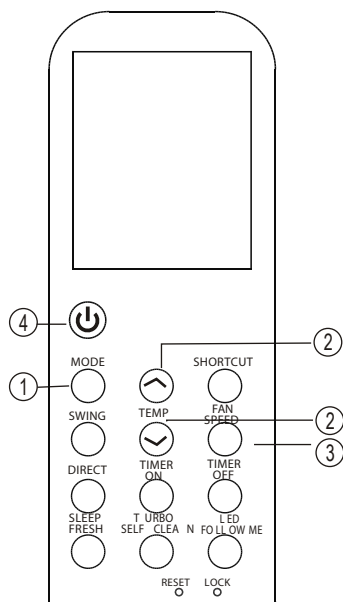
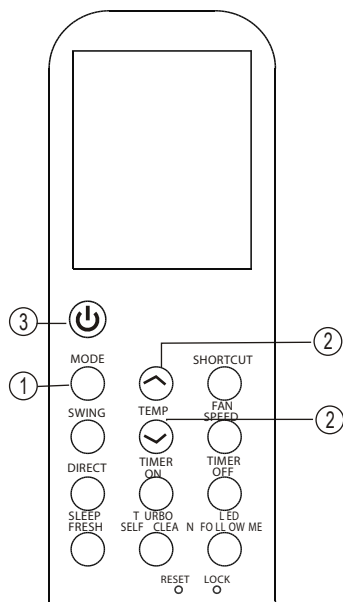

Λειτουργία Timer

Με το πλήκτρο TIMER ON μπορείτε να ρυθμίσετε την αυτόματη ενεργοποίηση της μονάδας και με το πλήκτρο TIMER OFF την αυτόματη απενεργοποίηση της μονάδας.

Ρύθμιση της ώρας της αυτόματης ενεργοποίησης της μονάδας.

1. Πιέστε το πλήκτρο TIMER ON. Στην οθόνη του ασύρματου τηλεχειριστηρίου θα εμφανιστεί η ένδειξη TIMER ON, η προηγούμενη ρύθμιση της ώρας που είχε γίνει και η ένδειξη "h". Τώρα μπορείτε να ρυθμίσετε την νέα ώρα αυτόματης ενεργοποίησης της μονάδας.
2. Πιέστε άλλη μια φορά το πλήκτρο TIMER ON για να ορίσετε την επιθυμητή ώρα της αυτόματης ενεργοποίησης της μονάδας. Κάθε φορά που πιέζετε το συγκεκριμένο πλήκτρο η ώρα θα αυξάνεται κατά 30λεπτά έως τις 10 ώρες και έπειτα κατά 1 ώρα έως τις 24
3. Αφού ολοκληρώσετε τη ρύθμιση του TIMER ON, θα υπάρξει μια χρονοκαυστέρηση ενάμιση δευτερολέπτου για την μετάδοση της εντολής από το ασύρματο τηλεχειριστήριο στην εσωτερική μονάδα. Μετά από άλλα 2 δευτερόλεπτα θα εξαφανιστεί η ένδειξη "h" από την οθόνη και θα επανεμφανιστεί η επιλεγμένη θερμοκρασία.

Ρύθμιση της ώρας της αυτόματης απενεργοποίησης της μονάδας.

1. Πιέστε το πλήκτρο TIMER OFF. Στην οθόνη του ασύρματου τηλεχειριστηρίου θα εμφανιστεί η ένδειξη TIMER OFF, η προηγούμενη ρύθμιση της ώρας που είχε γίνει και η ένδειξη "h". Τώρα μπορείτε να ρυθμίσετε την νέα ώρα αυτόματης απενεργοποίησης της μονάδας
2. Πιέστε άλλη μια φορά το πλήκτρο TIMER OFF για να ορίσετε την επιθυμητή ώρα της αυτόματης απενεργοποίησης της μονάδας. Κάθε φορά που πιέζετε το συγκεκριμένο πλήκτρο η ώρα θα αυξάνεται κατά 30λεπτά έως τις 10 ώρες και έπειτα κατά 1 ώρα έως τις 24 ώρες.
3. Αφού ολοκληρώσετε τη ρύθμιση του TIMER OFF, θα υπάρξει μια χρονοκαυστέρηση ενάμιση δευτερολέπτου για την μετάδοση της εντολής από το ασύρματο τηλεχειριστήριο στην εσωτερική μονάδα. Μετά από άλλα 2 δευτερόλεπτα θα εξαφανιστεί η ένδειξη "h" από την οθόνη και θα επανεμφανιστεί η επιλεγμένη θερμοκρασία.

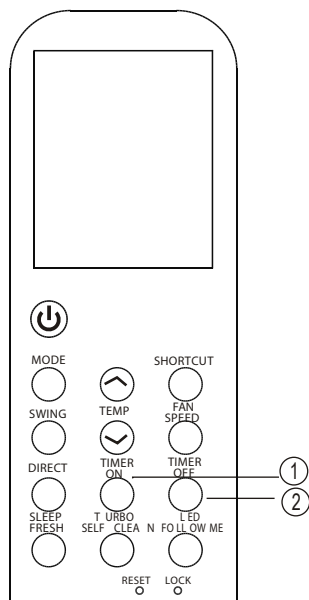

ΠΡΟΣΟΧΗ

- Οι ρυθμίσεις που μπορούν να γίνουν στο ασύρματο τηλεχειριστήριο για τη λειτουργία του timer είναι οι παρακάτω: 0.5, 1.0, 1.5, 2.0, 2.5, 3.0, 3.5, 4.0, 4.5, 5.0, 5.5, 6.0, 6.5, 7.0, 7.5, 8.0, 8.5, 9.0, 9.5, 10, 11, 12, 13, 14, 15, 16, 17, 18, 19, 20, 21, 22 and 24.

Παράδειγμα της ρύθμισης του Timer

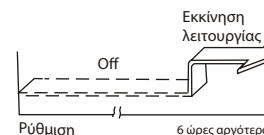

TIMER ON (Αυτόματη ενεργοποίηση της μονάδας)

Η λειτουργία TIMER ON είναι χρήσιμη όταν θέλετε η μονάδα να ενεργοποιηθεί αυτόματα πριν επιστρέψετε σπίτι. Η κλιματιστική μονάδα θα εκκινήσει αυτόματα την λειτουργία την ώρα που έχει επιλεγεί.

Παράδειγμα:

Ενεργοποίηση της κλιματιστικής μονάδας σε 6 ώρες.

1. Πιέστε το πλήκτρο TIMER ON. Στην οθόνη του ασύρματου τηλεχειριστηρίου θα εμφανιστεί η ένδειξη TIMER ON, η προηγούμενη ρύθμιση της ώρας που είχε γίνει και η ένδειξη "h".
2. Πιέστε το πλήκτρο TIMER ON μέχρι να εμφανιστεί στην οθόνη του ασύρματου τηλεχειριστηρίου η ένδειξη "6:0h".
3. Μετά από 3 δευτερόλεπτα θα επανεμφανιστεί στην οθόνη η επιλεγμένη θερμοκρασία. Τώρα έχει πλέον ενεργοποιηθεί η λειτουργία.

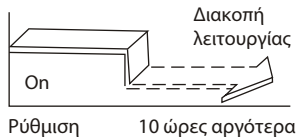

TIMER OFF (Αυτόματη απενεργοποίηση της μονάδας)

Η λειτουργία TIMER OFF είναι χρήσιμη όταν θέλετε να απενεργοποιηθεί η μονάδα όταν πέσετε για ύπνο. Η κλιματιστική μονάδα θα απενεργοποιηθεί αυτόματα την ώρα που έχει επιλεγεί.

Παράδειγμα:

Διακοπή λειτουργίας της κλιματιστικής μονάδας μετά από 10 ώρες.

1. Πιέστε το πλήκτρο TIMER OFF. Στην οθόνη του ασύρματου τηλεχειριστηρίου θα εμφανιστεί η ένδειξη TIMER OFF, η προηγούμενη ρύθμιση της ώρας που είχε γίνει και η ένδειξη "h".
2. Πιέστε το πλήκτρο TIMER OFF μέχρι να εμφανιστεί στην οθόνη του ασύρματου τηλεχειριστηρίου η ένδειξη "10h".
3. Μετά από 3 δευτερόλεπτα θα επανεμφανιστεί στην οθόνη η επιλεγμένη θερμοκρασία. Τώρα έχει πλέον ενεργοποιηθεί η λειτουργία.

Ταυτόχρονη ρύθμιση TIMER ON και TIMER OFF

TIMER OFF και TIMER ON

Διακοπή λειτουργίας -> Εκκίνηση λειτουργίας

Αυτή η ρύθμιση είναι χρήσιμη όταν θέλετε η κλιματιστική μονάδα να διακόψει τη λειτουργία της όταν ξαπλώσετε το βράδυ και να ενεργοποιηθεί η λειτουργία της όταν ξυπνήσετε το πρωί ή όταν επιστρέψετε στο σπίτι.

Παράδειγμα:

Διακοπή λειτουργίας της κλιματιστικής μονάδας 2 ώρες μετά την ρύθμιση και εκκίνηση λειτουργίας της μονάδας 10 ώρες μετά την ρύθμιση.

1. Πιέστε το πλήκτρο TIMER OFF.
2. Πιέστε το πλήκτρο TIMER OFF μέχρι να εμφανιστεί στην οθόνη η ένδειξη 2.0h.
3. Πιέστε το πλήκτρο TIMER ON.
4. Πιέστε το πλήκτρο TIMER ON μέχρι να εμφανιστεί στην οθόνη η ένδειξη 10h.
5. Περιμένετε μέχρι να εμφανιστεί στην οθόνη η επιλεγμένη θερμοκρασία.

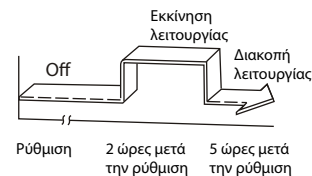

TIMER ON και TIMER OFF

Εκκίνηση λειτουργίας -> Διακοπή λειτουργίας

Αυτή η λειτουργία είναι χρήσιμη όταν θέλετε η κλιματιστική μονάδα να ενεργοποιηθεί πριν ξυπνήσετε και να διακόψει τη λειτουργία της όταν φύγετε από το σπίτι.

Παράδειγμα:

Ενεργοποίηση της κλιματιστικής μονάδας 2 ώρες μετά τη ρύθμιση και διακοπή λειτουργίας 5 ώρες μετά την ρύθμιση.

1. Πιέστε το πλήκτρο TIMER ON.
2. Πιέστε το πλήκτρο TIMER ON μέχρι να εμφανιστεί στην οθόνη η ένδειξη 2.0h.
3. Πιέστε το πλήκτρο TIMER OFF.
4. Πιέστε το πλήκτρο TIMER OFF μέχρι να εμφανιστεί στην οθόνη η ένδειξη 5.0h.
5. Περιμένετε μέχρι να εμφανιστεί στην οθόνη η επιλεγμένη θερμοκρασία.

ΣΗΜΕΙΩΣΗ: Η ρύθμιση του timer που θα ενεργοποιηθεί πρώτη είναι αυτή που θα εμφανιστεί αμέσως μετά την επιλογή της ώρας.

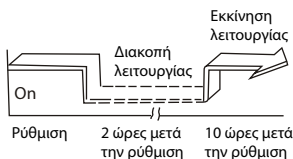
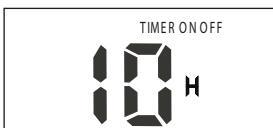

Λειτουργία SLEEP/FRESH

- Εάν πιέσετε το συγκεκριμένο πλήκτρο για λιγότερο από 2 δευτερόλεπτα θα ενεργοποιηθεί η λειτουργία SLEEP. Εάν πιέσετε το συγκεκριμένο πλήκτρο πάνω από 2 δευτερόλεπτα θα ενεργοποιηθεί η λειτουργία FRESH.
- Η λειτουργία SLEEP δίνει τη δυνατότητα στη μονάδα να αυξάνει (ψύξη) ή να μειώνει (θέρμανση) αυτόματα τη θερμοκρασία κατά 1°C για τις πρώτες 2 ώρες, έπειτα να διατηρεί σταθερή για 5 ώρες και έπειτα να διακόπτει τη λειτουργία της. Διατηρείται ιδανική θερμοκρασία και εξοικονομείται ενέργεια.
- **ΣΗΜΕΙΩΣΗ:** Η λειτουργία SLEEP είναι διαθέσιμη μόνο κατά τη λειτουργία ψύξης, θέρμανσης και αυτο.
- Όταν ενεργοποιηθεί η λειτουργία FRESH, ο ιονιστής/Plasma Dust Collector (ανάλογα το μοντέλο) θα ενεργοποιηθεί αντίστοιχα και θα απομακρυνθούν ακαθαρσίες από τον αέρα.

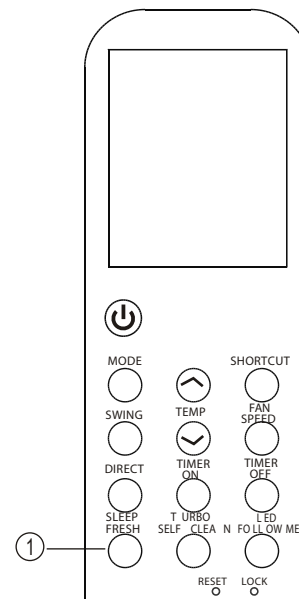

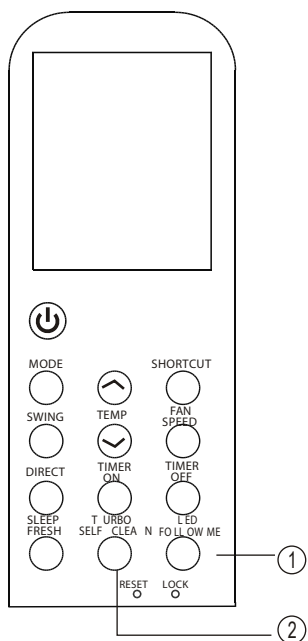

Λειτουργία LED/FOLLOW ME

- Πιέστε το πλήκτρο για λιγότερο από 2 δευτερόλεπτα για να ενεργοποιήσετε τη λειτουργία LED. Αν πιέσετε το συγκεκριμένο πλήκτρο πάνω από 2 δευτερόλεπτα θα ενεργοποιηθεί η λειτουργία FOLLOW ME.
- Όταν η λειτουργία FOLLOW ME είναι ενεργοποιημένη, η μονάδα ρυθμίζει τη θερμοκρασία του χώρου σύμφωνα με τη θέση που βρίσκεται το ασύρματο τηλεχειριστήριο. Το ασύρματο τηλεχειριστήριο θα δίνει εντολή στην μονάδα ανά 3 δευτερόλεπτα. Αν πιέσετε το πλήκτρο άλλη μια φορά η λειτουργία θα ακυρωθεί.
- Η λειτουργία FOLLOW ME δεν είναι διαθέσιμη κατά τις λειτουργίες DRY και FAN.
- Εάν αλλάξετε την κατάσταση λειτουργίας ή απενεργοποιήσετε τη μονάδα η λειτουργία FOLLOW ME θα ακυρωθεί αυτόματα.

Λειτουργία TURBO/SELF CLEAN

- Εάν πιέσετε το πλήκτρο για λιγότερο από 2 δευτερόλεπτα θα ενεργοποιηθεί η λειτουργία TURBO. Αν πιέσετε το συγκεκριμένο πλήκτρο για περισσότερο από 2 δευτερόλεπτα θα ενεργοποιηθεί η λειτουργία SELF CLEAN.
- Με τη λειτουργία TURBO επιτυγχάνεται γρηγορότερα η επιθυμητή θερμοκρασία στον χώρο. Όταν πιέσετε το συγκεκριμένο πλήκτρο κατά τη λειτουργία της ψύξης, η μονάδα θα λειτουργήσει στην πολλή υψηλή ταχύτητα. Όταν πιέσετε το πλήκτρο TURBO κατά τη λειτουργία της θέρμανσης (διαθέσιμη μόνο για της μονάδες με αντίσταση PTC), θα ενεργοποιηθεί η αντίσταση για γρηγοτότερη θέρμανση.
- Όταν επιλέξετε τη λειτουργία SELF CLEAN, η μονάδα θα ενεργοποιήσει τον αυτόματο καθαρισμό και την απομάκρυνση της υγρασίας από το στοιχείο της μονάδας, ώστε να είναι καθαρό για την επόμενη λειτουργία.

CUPRINS

Manevrarea telecomenzii	2
Specificațiile telecomenzii	3
Funcțiile tastelor.....	5
Indicatorii de pe afișajul LCD.....	8
Cum să folosiți tastele	9
Funcționarea Auto	9
Răcire / Încălzire / Ventilare	9
Funcția de Dezumidificare	10
Ajustarea fluxului de aer	10
Funcția de programare	11
Funcția SLEEP/FRESH	14
Funcția LED/FOLLOW ME	15
Funcția TURBO/AUTO-CURĂȚARE	15

Manevrarea telecomenzii

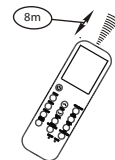
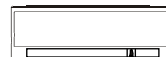

Locația telecomenzii

- Utilizați telecomanda într-o distanță de 8 metri față de aparat, îndreptând telecomanda înspre echipament. Recepția semnalului este confirmată de un semnal sonor

⚠ ATENȚIE

- Aparatul de aer condiționat nu va funcționa dacă draperiile, ușile sau alte materiale, blochează semnalul de la telecomandă către unitatea internă
- Evitați vărsarea oricărui lichid pe telecomandă. Nu expuneți telecomandă direct razelor solare sau căldurii excesive.
- Dacă receptorul de semnal infraroșu al unității interne este expus direct razelor solare, aparatul de aer condiționat s-ar putea să funcționeze anormal. Folosiți draperiile pentru a preveni razele solare să ajungă la receptorul de semnal infraroșu
- Dacă orice alt echipament electrocasnic reacționează la telecomanda aparatului de aer condiționat, fie mutați acel echipament, fie consultați furnizorul dvs local

Înlocuirea bateriilor

NOTĂ: Înlocuiți bateriile atunci când nu se mai aude semnalul sonor de la unitatea internă de confirmare a primirii semnalului sau când afișajul de pe telecomandă nu se mai aprinde. Telecomanda este alimentată de două baterii (R03/LR03X2) localizate în partea din spate și sunt protejate de un capac

- (1) Îndepărtați capacul prin apăsare și glisare
- (2) Înlăturați vechile baterii și introduceți bateriile noi respectând (+) și (-)
- (3) Reatașați capacul prin glisare până ajunge la poziția inițială.

NOTĂ: Când scoateți bateriile, telecomanda își pierde toate programările. După ce introduceți noile baterii, telecomanda trebuie reprogramată

⚠ ATENȚIE

- Nu amestecați bateriile vechi cu cele noi sau diverse tipuri de baterii.
- Nu lăsați bateriile în telecomandă dacă nu le folosiți o perioadă mai mare de 2 sau 3 luni.
- Nu aruncați bateriile cu gunoiul menajer. Colectările separate pentru că este necesar aplicarea unui tratament special.

Specificațiile telecomanzii

Model	RG35A(2)/BG(C)EF, RG35A1(4)/BG(C)EF, RG35B/BG(C)E, RG35C/BG(C)E, RG36B3/BGE, RG36A(1)/BG(C)EF, RG36A2/BG(C)EF, RG36B(1)/BG(C)E, RG36C/BG(C)E
Tensiune Nominală	3.0V (Baterii R03/LR03 x2)
Interval de Primire Semnal	8m
Mediu ambient	-5 °C ~ 60 °C

Caracteristici de Performanță

1. Mod de Funcționare: AUTO, RĂCIRE, DEZUMIDIFICARE, ÎNCĂLZIRE (nu este disponibil la modelele DOAR RĂCIRE), și VENTILARE
2. Posibilitate programare 24 ore
3. Setarea temperaturii interne între 17 °C~30 °C.
4. Afișaj complet (Ecran cu Cristale Lichide)

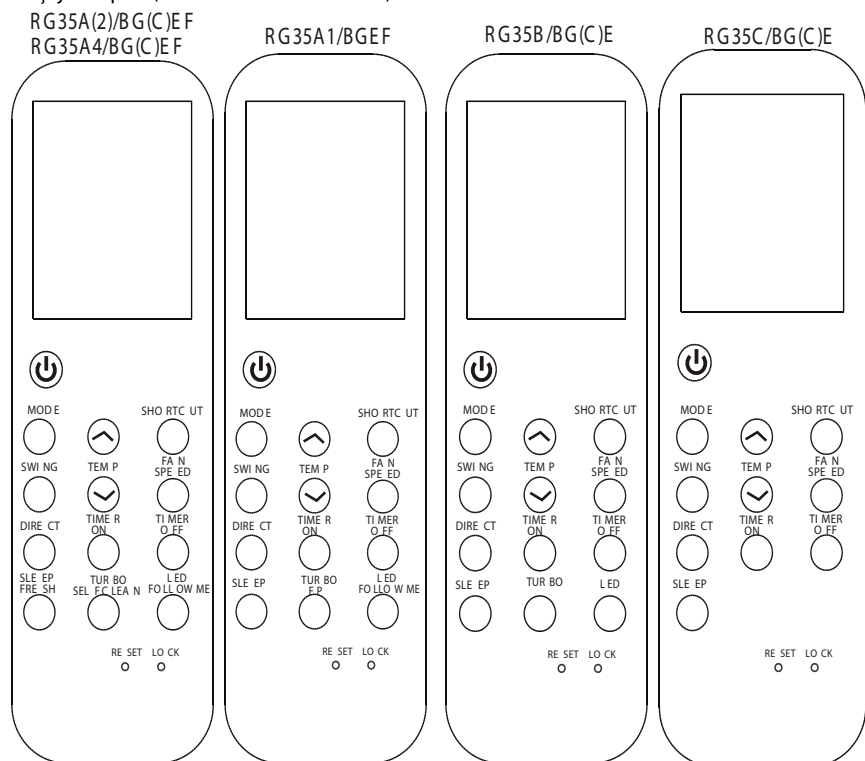

3

RG36A(1)/BG(C)EF

RG36A2/BG(C)EF

RG36B(1)/BG(C)E
RG36B3/BGE

RG36C/BG(C)E

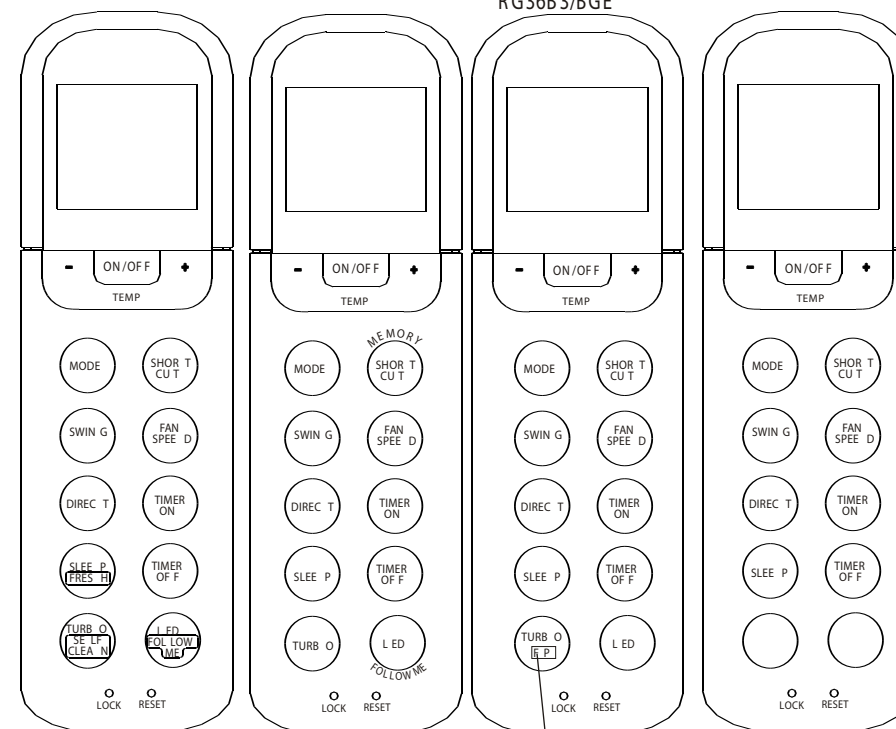

Modelele RG36B(3)/BG(C)E
nu au funcția FP.

NOTĂ: Există doar o mică diferență între modelele RG35 și RG36. Funcțiile tastelor sunt similare. Unele taste au două funcții, unele taste doar o funcție. Spre exemplu SLEEP FRESH

și SLEEP.



Vă rugăm să consultați imaginile de mai sus pentru detalii



4

Funcțiile tastelor

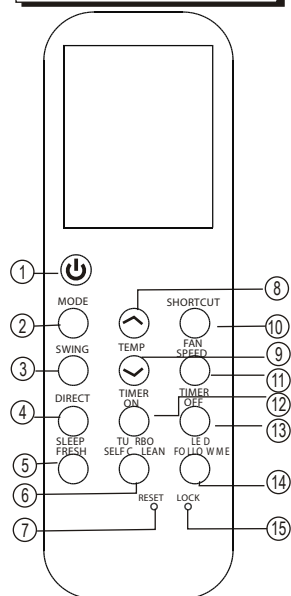

RG35A(2)

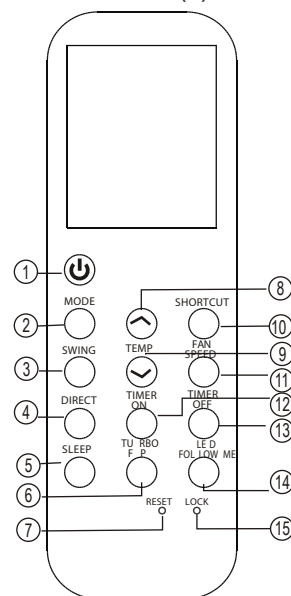

RG35A1

- Tasta PORNIT/OPRIT (/ ON/OFF)**
Funcționarea aparatului începe când se apasă această tastă și se oprește când apăsăm din nou tasta.
- Tasta MOD**
De fiecare dată când apăsăm această tastă, modul de funcționare al aparatului este selectat în următoarea succesiune:

NOTĂ: Modul de Încălzire este disponibil pentru aparatele care au funcție de Răcire și Încălzire

- Tasta de mișcare a flapsurilor**
Folosită pentru a porni sau a opri mișcarea flapsurilor
 - Tasta DIRECT**
Folosită pentru a schimba unghiul de mișcare a flapsurilor și setarea lor în poziția dorită. Flapsurile își schimbă poziția cu 6° la fiecare apăsare
 - Tasta SLEEP/FRESH**
Activează/Dezactivează funcția SLEEP. Dacă se apasă mai mult de 2 secunde, funcția FRESH se va activa, iar dacă apăsăm iar 2 secunde funcția se va dezactiva.
 - Tasta TURBO/AUTO-CURĂȚARE**
 - Activează/Dezactivează funcția TURBO. Dacă se apasă mai mult de 2 secunde, se va activa funcția de AUTO-CURĂȚARE, iar dacă apăsăm iar pentru 2 secunde se va dezactiva (depinde de model)
- Tasta TURBO/FP**
- Activează/Dezactivează funcția TURBO. Dacă apăsăm mai mult de 2 secunde în timp ce aparatul funcționează în Modul de Încălzire (când este selectat Modul de Încălzire), aparatul va funcționa la o viteză mare a ventilatorului și cu o temperatură setată la 8°C. Pe afișajul de la unitatea internă va apărea scris FP. Pentru aparatele care nu au afișaj la unitatea internă, led-ul care indică degivrarea va rămâne aprins timp de 2 secunde după care se va stinge pentru alte 2 secunde. Apăsați PORNIT/OPRIT, SLEEP, FP, MOD, VENTILARE, VITEZĂ VENTILATOR, SUS, JOS sau SCURTĂTURĂ și funcția FP va fi anulată.

5

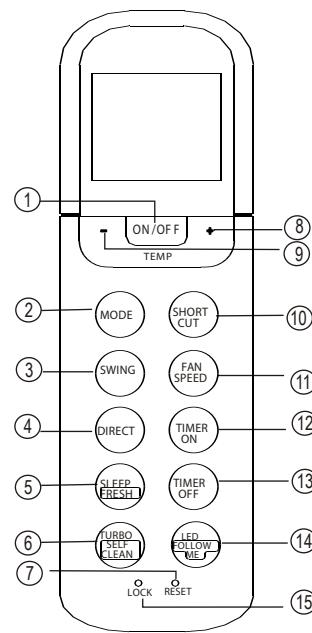

RG36A(1)

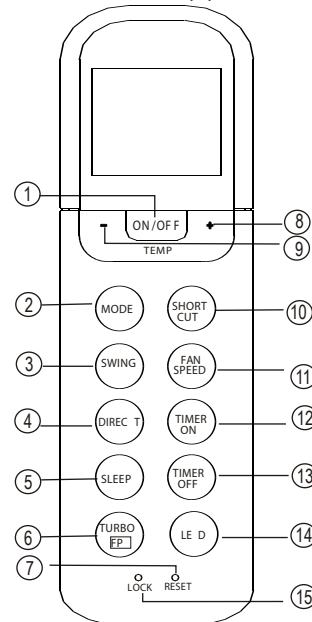

RG36B1

- Tasta RESETARE**
Când apăsați tasta RESETARE, toate setările sunt anulate și telecomanda se va întoarce la setările inițiale.
- Tasta SUS (/ +)**
Apăsați această tastă pentru a crește temperatura setată sau pentru a crește timpul de funcționare în timpul funcționării programate.
- Tasta JOS (/ -)**
Apăsați această tastă pentru a crește temperatura setată sau pentru a crește timpul de funcționare în timpul funcționării programate.
- Tasta SCURTĂTURĂ (COMENZI RAPIDE)**
 - Folosită să restaureze setările curente sau să revină la cele precedente.
 - Când aparatul este conectat prima dată la priză și dacă apăsați tasta COMENZI RAPIDE, acesta va funcționa în modul AUTO, 24°C, și viteza ventilatorului este automată
 - Apăsați această tastă când telecomanda este pornită, și aparatul se va întoarce în mod automat la setările precedente inclusiv ca și mod de funcționare, temperatură setată, viteza ventilatorului sau funcția SLEEP (dacă este activată). Telecomanda va transmite semnalul la unitatea internă
 - Dacă apăsăm această tastă când telecomanda este oprită, aparatul se va întoarce doar la setările precedente și telecomanda nu va transmite semnalul la unitatea internă.
 - Dacă apăsăm mai mult de 2 secunde, aparatul va reveni la setările precedente incluzând modul de funcționare, temperatura setată, viteza ventilatorului și funcția SLEEP (dacă este activată)
- Tasta VITEZĂ VENTILATOR**
Folosită pentru a seta viteza ventilatorului în 4 pași:
- Tasta PROGRAMARE PORNIRE**
Apăsați această tastă pentru a iniția pornirea programată. Când va apărea pe afișaj 10H, fiecare apăsare va crește setarea timpului cu 60 de minute. Pentru a anula pornirea programată, ajustați timpul de pornire programată la 0.0.

6

Funcțiile tastelor (continuare)

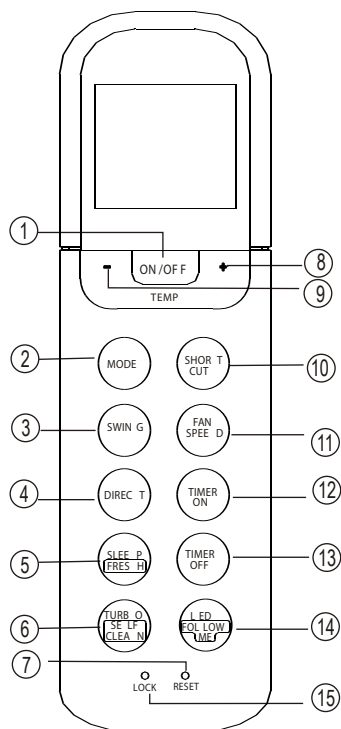

13 Tasta PROGRAMARE OPRIRE
Apăsați această tastă pentru a iniția oprirea programată. Când va apărea pe afișaj 10H, fiecare apăsare va crește setarea timpului cu 60 de minute. Pentru a anula oprirea programată, ajustați timpul de oprire programată la 0.0.

14 Tasta LED/FOLLOW ME
Activează/Dezactivează afișajul de la unitatea internă. Când se apasă mai mult de 2 secunde, funcția FOLLOW ME va fi activată iar încă o apăsare de 2 secunde o va dezactiva.

15 Tastă BLOCARE
Când apăsați tasta BLOCARE, toate setările curente sunt blocate iar telecomanda nu acceptă nicio alta funcție decât BLOCARE. Apăsați din nou pentru a anula blocarea tastaturii.

NOTĂ:

- Modelele de taste pot fi ușor diferite în funcție de aparatul pe care l-ați cumpărat
- Toate funcțiile descrise mai sus sunt îndeplinite de unitatea internă. Dacă această unitate nu are funcția respectivă, nu va răspunde corespunzător la apăsarea tastei de pe telecomandă.

Indicatorii de pe afișajul LCD

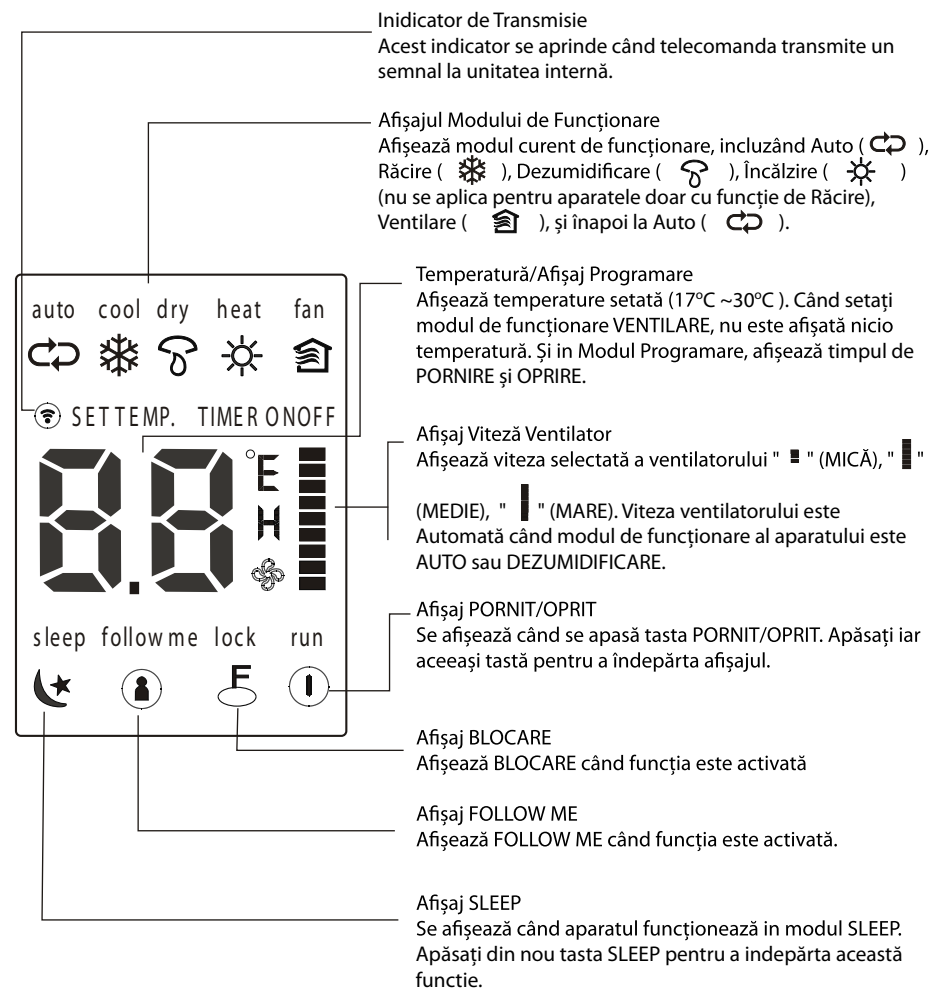

Notă:

Toți indicatorii arătați în figura sunt cu scop de prezentare. Dar în timpul funcționării reale, numai anumiți indicatori sunt prezenți pe afișajul unității

Cum să folosiți tastele

Funcționarea Auto

Asigurați-vă că aparatul este conectat la priză și există tensiune în rețeaua electrică. Indicatorul de FUNCȚIONARE de pe unitatea internă începe să pâlpâie

1. Apăsați tasta MOD pentru a selecta AUTO
2. Apăsați tasta SUS/JOS pentru a seta temperatura dorită. Aceasta poate fi setată în intervalul 17°C~ 30°C cu creștere de 1°C
3. Apăsați tasta PORNIT/OPRIT pentru a porni aparatul de aer condiționat.

NOTĂ

1. În modul de funcționare Auto, aparatul de aer condiționat poate alege în mod logic, unul din modurile de funcționare Răcire, Ventilare sau Încălzire prin diferențierea între temperatura reală din cameră și temperatura setată pe telecomandă.
2. În modul de funcționare Auto nu puteți schimba viteza ventilatorului. Este controlată în mod automat.
3. Dacă modul de funcționare Auto nu este confortabil pentru dvs, puteți selecta manual un alt mod de funcționare.

Modul Răcire/Încălzire/Ventilare

Asigurați-vă că aparatul este conectat la priză și există tensiune în rețeaua electrică. Indicatorul de FUNCȚIONARE de pe unitatea internă începe să pâlpâie.

1. Apăsați tasta MOD pentru a selecta RĂCIRE, ÎNCĂLZIRE (pentru modelele care au în dotare aceste funcții) sau VENTILARE
2. Apăsați tasta SUS/JOS pentru a seta temperatura dorită. Aceasta poate fi setată în intervalul 17°C~ 30°C cu creștere de 1°C
3. Apăsați tasta VENTILARE pentru a selecta viteza ventilatorului în patru pași – Auto, Mică, Medie, Mare.
4. Apăsați tasta PORNIT/OPRIT pentru a porni aparatul de aer condiționat.

NOTĂ

În modul de VENTILARE, temperatura setată nu este afișată pe telecomandă și dvs nu puteți controla temperatura camerei. În acest caz puteți urma numai pașii 1, 3 și 4.

Funcția de Dezumidificare

Asigurați-vă că aparatul este conectat la priză și există tensiune în rețeaua electrică. Indicatorul de FUNCȚIONARE de pe unitatea internă începe să pâlpâie

1. Apăsați tasta MOD pentru a selecta modul de funcționare DEZUMIDIFICARE.
2. Apăsați tasta SUS/JOS pentru a seta temperatura dorită. Aceasta poate fi setată în intervalul 17°C~ 30°C cu creștere de 1°C
3. Apăsați tasta PORNIT/OPRIT pentru a porni aparatul de aer condiționat.

NOTĂ

În modul de Dezumidificare nu puteți schimba viteza ventilatorului. Este controlată automat.

Ajustarea fluxului de aer

Folosiți tasta SWING și DIRECT pentru a ajusta fluxul de aer în direcția dorită.

1. Când apăsați tasta DIRECT, flapsurile orizontale își schimbă unghiul cu 6 grade la fiecare apăsare.
2. Când apăsați tasta SWING, flapsurile se vor mișca în sus și jos în mod automat.

NOTĂ

Când flapsurile se mută într-o poziție care afectează răcirea sau încălzirea camerei, acestea se vor muta automat în altă poziție

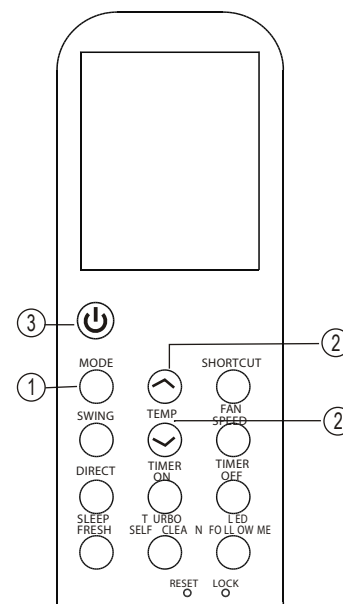
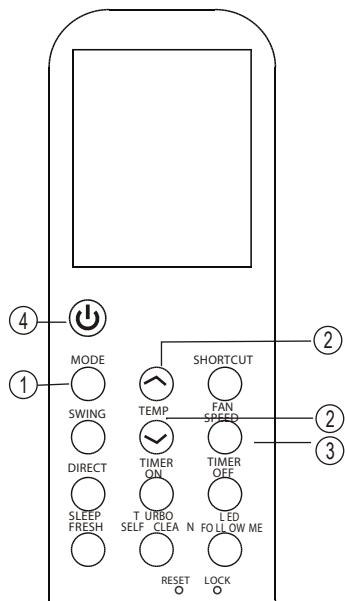
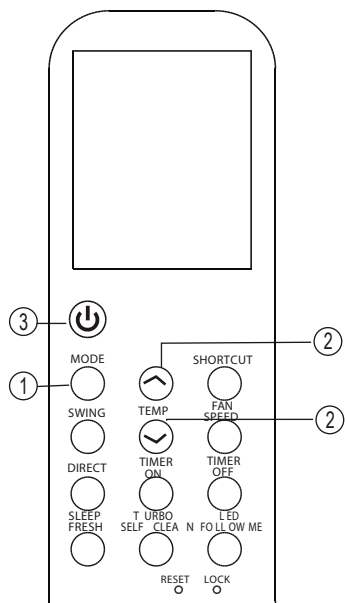

Funcționarea Programată

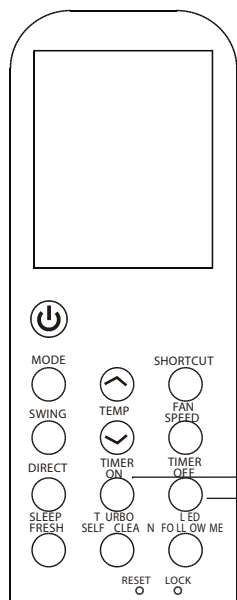

1. Apăsați tasta TIMER ON. Pe telecomandă va apărea TIMER ON, ultima setare programată și semnul "h". Aparatul acum este pregătit pentru o setare de pornire programată.

2. Apăsați din nou tasta TIMER ON pentru a ajunge la timpul dorit de dvs. Cu fiecare apăsare, timpul de programare crește cu jumătate de oră și o oră când setarea se face între 10 și 24 de ore.

3. După setarea timpului de pornire programată, va exista o secundă de întârziere până ce telecomanda va transmite semnalul la unitatea internă. Apoi, după alte aproximativ 2 secunde, semnul "h" va dispărea și pe afișajul telecomenzii va reapărea temperatura setată

Pentru a seta timpul Automat de Oprire

1. Apăsați tasta TIMER OFF. Pe telecomandă va apărea TIMER OFF, ultima setare programată și semnul "h". Aparatul acum este pregătit pentru o setare de oprire programată.

2. Apăsați din nou tasta TIMER OFF pentru a ajunge la timpul dorit de dvs. Cu fiecare apăsare, timpul de programare crește cu jumătate de oră și o oră când setarea se face între 10 și 24 de ore.

3. După setarea timpului de oprire programată, va exista o secundă de întârziere până ce telecomanda va transmite semnalul la unitatea internă. Apoi, după alte aproximativ 2 secunde, semnul "h" va dispărea și pe afișajul telecomenzii va reapărea temperatura setată.

ATENȚIE

- Timpul efectiv de programare setat pe telecomandă este limitat la următoarele posibilități: 0.5, 1.0, 1.5, 2.0, 2.5, 3.0, 3.5, 4.0, 4.5, 5.0, 5.5, 6.0, 6.5, 7.0, 7.5, 8.0, 8.5, 9.0, 9.5, 10, 11, 12, 13, 14, 15, 16, 17, 18, 19, 20, 21, 22, 23 and 24.

Exemplu de setare programată

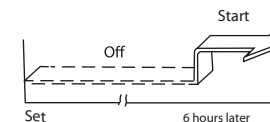

PORNIRE AUTOMATĂ (FUNCȚIONARE AUTOMATĂ)

PORNIREA PROGRAMATĂ este folositoare când doriți ca aparatul de aer condiționat să pornească înainte să ajungeți acasă. Acesta va porni la ora setată de dvs

Exemplu:

- Pentru a porni aparatul de aer condiționat în 6 ore
1. Apăsați tasta TIMER ON și ultimele setări împreună cu semnul "h" vor fi afișate.
 2. Apăsați TIMER ON pentru ca pe afișajul telecomenzii să apară "6:0h".
 3. Așteptați 3 secunde și pe afișajul telecomenzii va apărea din nou temperatura setată.



OPRIRE AUTOMATĂ (FUNCȚIONARE AUTOMATĂ)

Această funcție este utilă când doriți ca aparatul să se oprească în mod automat după ce v-ați dus la culcare. Aparatul se va opri automat la ora setată de dvs.

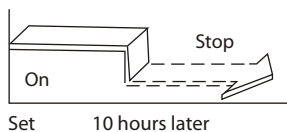

Exemplu:

1. Apăsați tasta TIMER OFF și ulimele setări împreună cu semnul "h" vor fi afișate.
2. Apăsați TIMER OFF pentru ca pe afișajul telecomenzii să apară "10h".
3. Așteptați 3 secunde și pe afișajul telecomenzii va apărea din nou temperatura setată. Indicatorul TIMER OFF va rămâne activ și funcția activată

PROGRAMARE COMBINATĂ (Setarea simultană a timpului de Pornire și Oprire automată)

OPRIRE AUTOMATĂ -> PORNIRE AUTOMATĂ

Această funcție este utilă când doriți ca aparatul să se oprească după ce v-ați dus la culcare și să pornească din nou când vă treziți sau când vă întoarceți acasă.

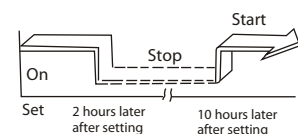
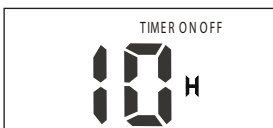

Exemplu:

Să opriți aparatul de aer condiționat la 2 ore după setare și să pornească iar la 10 ore de la setare.

1. Apăsați tasta TIMER OFF.
2. Apăsați tasta TIMER OFF din nou până apare 2.0h pe afișajul telecomenzii
3. Apăsați tasta TIMER ON.
4. Apăsați tasta TIMER ON din nou până apare 10h pe afișajul telecomenzii
5. Așteptați 3 secunde și pe afișajul telecomenzii va apărea din nou temperatura setată. Indicatorul TIMER ON OFF va rămâne activ și funcția activată



PORNIRE AUTOMATĂ -> OPRIRE AUTOMATĂ

(Oprit > Pornit > Start Programare)

Această funcție este utilă când doriți să porniți aparatul de aer condiționat înainte să vă treziți și să se oprească după ce plecați de acasă

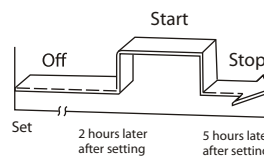

Exemplu:

Să pornească la 2 ore de la setare și să se oprească la 5 ore după setare.

1. Apăsați tasta TIMER ON.
2. Apăsați tasta TIMER ON din nou până apare 2.0h pe afișajul telecomenzii.
3. Apăsați tasta TIMER OFF
4. Apăsați tasta TIMER OFF din nou până apare 5.0h pe afișajul telecomenzii.
5. Așteptați 3 secunde și pe afișajul telecomenzii va apărea din nou temperatura setată. Indicatorul TIMER ON OFF va rămâne activă și funcția activată.

NOTĂ

Setarea programării (TIMER ON și TIMER OFF) apare după ce timpul de programare a fost setat

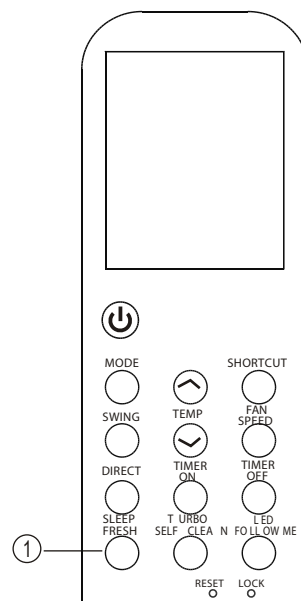

Funcția SLEEP/FRESH

- Apăsați tasta mai puțin de 2 secunde pentru a iniția funcția SLEEP. Dacă apăsați mai mult de 2 secunde se va activa funcția FRESH
- Funcția SLEEP permite creșterea automată a temperaturii (în Răcire) sau scăderea (în Încălzire) cu 1°C pe oră, în primele două ore și rămâne constant pentru următoarele 5 ore, după care aparatul se va opri. În acest mod se menține cea mai confortabilă temperatură cu economie de energie electrică
- **NOTĂ:** Funcția SLEEP este valabilă doar în modulurile de funcționare Răcire, Încălzire și Auto.
- Când se activează funcția FRESH, Ionizatorul/Colectorul de Praf cu Plasmă (depinde de model) este de asemenea activat și îndepărtează din aer polenul și impuritățile.

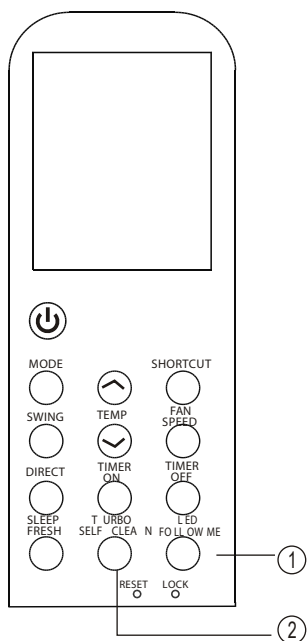

Funcția LED/FOLLOW ME

- Apăsați tasta mai puțin de 2 secunde pentru a activa funcția LED. Dacă apăsați mai mult de 2 secunde se activează funcția FOLLOW ME.
- Când funcția FOLLOW ME este activă, telecomanda afișează temperatura locală de unde este poziționată.
- Telecomanda va trimite un semnal la unitatea internă la un interval de 3 minute până se apasă din nou tasta FOLLOW ME.
- Funcția Follow Me nu este valabilă în modurile de funcționare DEZUMIDIFICARE sau VENTILARE. Schimbați modul de funcționare sau opriți aparatul pentru a dezactiva funcția automată Follow Me.

Funcția TURBO/AUTO-CURĂȚARE

- Apăsați mai puțin de 2 secunde și funcția TURBO se va activa. Dacă apăsați mai mult de 2 secunde se va activa funcția de AUTO-CURĂȚARE
Funcția TURBO permite aparatului să ajungă la temperatura dorită în cel mai scurt timp. Când se apasă această tastă în modul de răcire, unitatea internă va sufla puternic un aer rece la o viteză mare a ventilatorului.
- Când se apasă această tastă în modul de încălzire (aplicabil pentru unități cu PTC), acesta se va activa și va produce o încălzire rapidă
- În funcția de AUTO-CURĂȚARE, aparatul de aer condiționat va curăța și usca în mod automat vaporizatorul și îl va menține curat pentru următoarea funcționare