

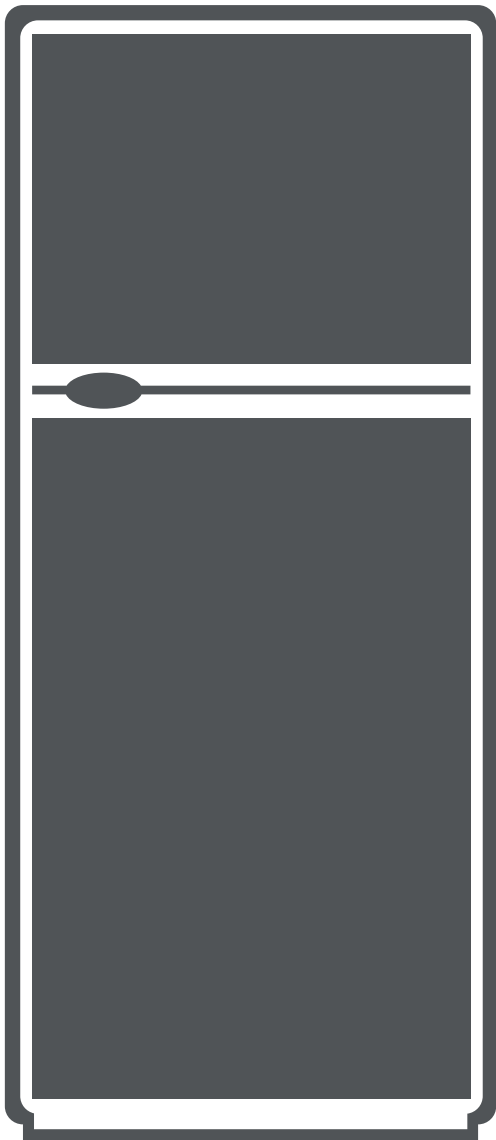

REFRIGERATOR DOUBLE DOOR

- USER'S MANUAL
- ΕΓΧΕΙΡΙΔΙΟ ΧΡΗΣΗΣ
- MANUAL DE UTILIZARE



MODELS:

DP1446S
DP1444IN
DP1440W



Contents

1.	SAFETY WARNINGS.....	1
2.	INSTALLTION.....	3
2.1	Location.....	3
2.2	Reversing the Door Swing (optional)	3
2.3	Door Handle Install Illumination (optional)	7
2.4	Door Space Requirements.....	8
2.5	Levelling the Unit	8
2.6	Cleaning Before Use	8
2.7	Before Using Your Unit.....	8
2.8	Interior Accessories.....	9
3.	PRODUCT OVERVIEW	9
4.	OPERATION.....	10
4.1	Switching On Your Unit	10
4.2	Noise Inside the Unit.....	10
4.3	Tips for Keeping Food in the Unit.....	10
4.4	Change the Light Bulb	10
5.	CLEANING	11
5.1	Defrosting.....	11
5.2	Cleaning the Interior and the Exterior of the Unit	11
5.3	Cleaning Tips	11
6.	MAINTENANCE	11
6.1	Changing the Internal Light.....	11
6.2	Care When Handling / Moving Your Unit.....	12
6.3	Servicing	12
6.4	Switching Of for Long Periods of Time	12
7.	Trouble shooting	12
7.1	Warm tips:.....	12
8.	FOR ENERGY SAVING	13
9.	DISPOSAL	13

1. SAFETY WARNINGS



Warning: risk of fire / flammable materials

THIS appliance is intended to be used in household and similar applications such as staff kitchen areas in shops, offices and other working environments; farm houses and by clients in hotels, motels and other residential type environments; bed and breakfast type environments; catering and similar non-retail applications.

THIS appliance is not intended for use by persons (including children) with reduced physical, sensory or mental capabilities, or lack of experience and knowledge, unless they have been given supervision or instruction concerning use of the appliance by a person responsible for their safety.)

Children should be supervised to ensure that they do not play with the appliance.

IF the supply cord is damaged, it must be replaced by the manufacturer, its service agent or similarly qualified persons in order to avoid a hazard.

DO not store explosive substances such as aerosol cans with a flammable propellant in this appliance.

THE appliance has to be unplugged after use and before carrying out user maintenance on the appliance.

WARNING: Keep ventilation openings, in the appliance enclosure or in the built-in structure, clear of obstruction.

WARNING: Do not use mechanical devices or other means to accelerate the defrosting process, other than those recommended by the manufacturer.

WARNING: Do not damage the refrigerant circuit.

WARNING: Do not use electrical appliances inside the food storage compartments of the appliance, unless they are of the type recommended by the manufacturer.

WARNING: Please abandon the refrigerator according to local regulators for its use of flammable blowing gas and refrigerant.

WARNING: When positioning the appliance, ensure the supply cord is not trapped or damaged.

WARNING: Do not locate multiple portable socket-outlets or portable power supplies at the rear of the appliance.

DO not use extension cords or ungrounded (two prong) adapters.

DANGER: Risk of child entrapment. Before you throw away your old refrigerator or freezer:

-Take off the doors.

-Leave the shelves in place so that children may not easily climb inside.

THE refrigerator must be disconnected from the source of electrical supply before attempting the installation of accessory.

REFRIGERANT and cyclopentane foaming material used for the appliance are flammable. Therefore, when the appliance is scrapped, it shall be kept away from any fire source and be recovered by a special recovering company with corresponding qualification other than be disposed by combustion, so as to prevent damage to the environment or any other harm.

FOR EN standard: This appliance can be used by children aged from 8 years and above and persons with reduce physical sensory or mental capabilities or lack of experience and knowledge if they have been given supervision or instruction concerning use of the appliance in a safe way and understand the hazards involved. Children shall not play with the appliance. Cleaning and user maintenance shall not be made by children without supervision. Children aged from 3 to 8 years are allowed to load and unload refrigerating appliances.

The necessity that, for doors or lids fitted with locks and keys, the keys be kept out of the reach of children and not in the vicinity of the refrigerating appliance, in order to prevent children from being locked inside.

TO avoid contamination of food, please respect the following instructions:

- Opening the door for long periods can cause a significant increase of the temperature in the compartments of the appliance.
- Clean regularly surfaces that can come in contact with food and accessible drainage systems.
- Clean water tanks if they have not been used for 48 h; flush the water system connected to a water supply if water has not been drawn for 5 days. (note 1)
- Store raw meat and fish in suitable containers in the refrigerator, so that it is not in contact with or drip onto other food.
- Two-star frozen-food compartments are suitable for storing pre-frozen food, storing or making ice-cream and making ice cubes. (note 2)
- One -, two - and three-star compartments are not suitable for the freezing of fresh food. (note 3) .
- If the refrigerating appliance is left empty for long periods, switch off, defrost, clean, dry, and leave the door open to prevent mould developing within the appliance.
- For appliances without a 4-star compartment: this refrigerating appliance is not suitable for freezing foodstuffs. (note 4)

Note 1,2,3,4: Please confirm whether it is applicable according to your product compartment type.

FOR a freestanding appliance: this refrigerating appliance is not intended to be used as a built-in appliance.

ANY replacement or maintenance of the LED lamps is intended to be made by the manufacturer, its service agent or similar qualified person.

2. INSTALLTION

2.1 Location

When selecting a position for your unit you should make sure the floor is flat and firm, and the room is well ventilated. Avoid locating your unit near a heat source, e.g. cooker, boiler or radiator. Also avoid direct sunlight as it may increase the electrical consumption. Extreme cold ambient temperatures may also cause the unit not to perform properly. This unit is not designed for use in a garage or outdoor installation. Do not drape the unit with any covering.

When installing the unit, ensure that 10 cm of free space is left at both sides, 10 cm at the rear and 30 cm at the top of the unit. This will allow cold air to circulate around the wine cooler and improve the efficiency of the cooling process.

2.2 Reversing the Door Swing (optional)

Tools Required: Phillips style screwdriver / Flat blated screwdriver / Hexagonal spanner

- 1) Remove the top hinge cover .

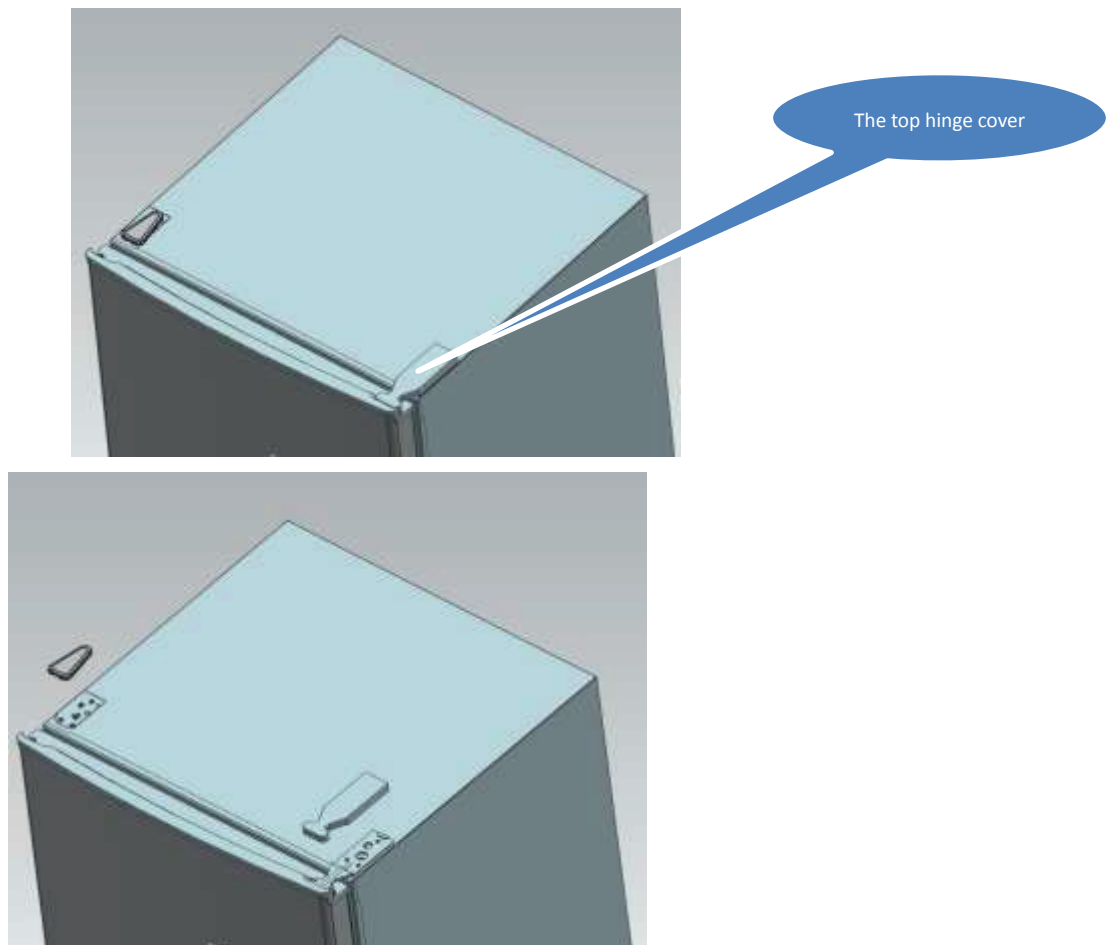

- 2) Remove the screws fixed the top-hinge with cross-slot screwdriver.

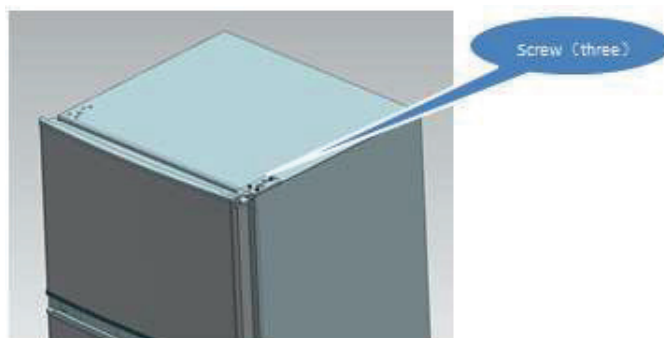

- 3) Replace the top-hinge and the top-door limit block and the door bearing bush to the other side.

- A. Remove the nut with sleeve. Take off the washer then remove the axes to the other side and fixed.



- B. Remove the door limit block

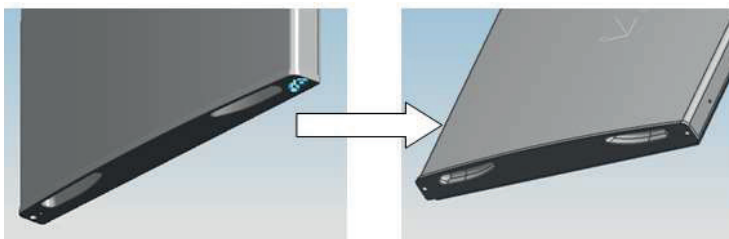

- C. Please taking out another door limit block, with screw mounting to the door



- 4) Disassemble the screws fixed the bottom-hinge with cross-slot screwdriver .

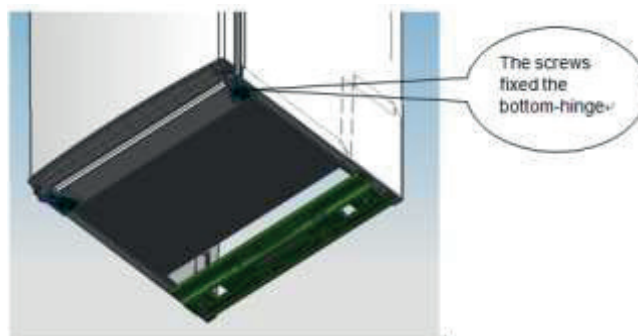

Note: the refrigerator-freezer incline angle less 45° .

- 5) Replace the bottom door bearing bush and the limit block.

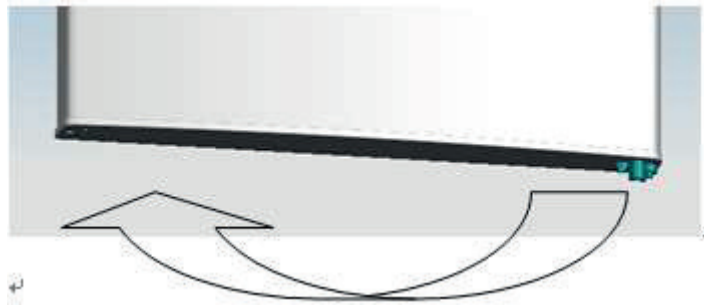

- 6) Replace the bottom hinge to the other side then fix it with screws.

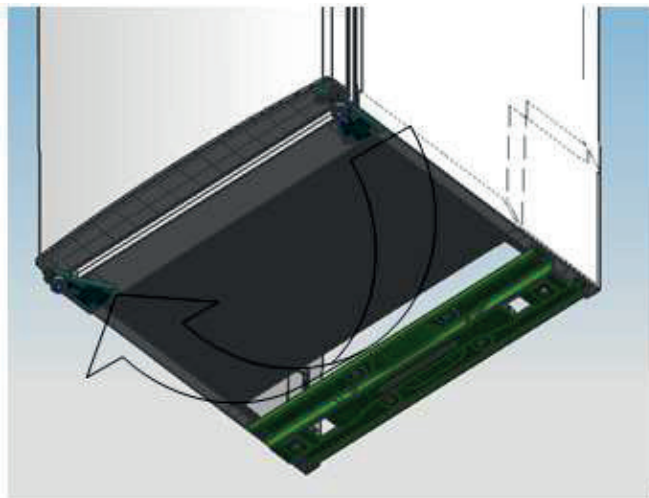

- 7) Replace the mid-hinge.



- 8) Set the bottom door right position, fix the mid-hinge.



9) Replace the top-hinge.

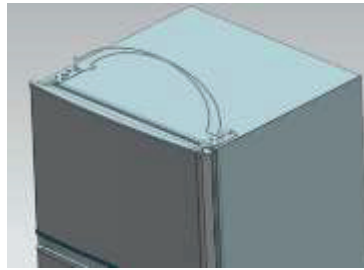

10) Set the top door right position, fix the top-hinge and the cover.

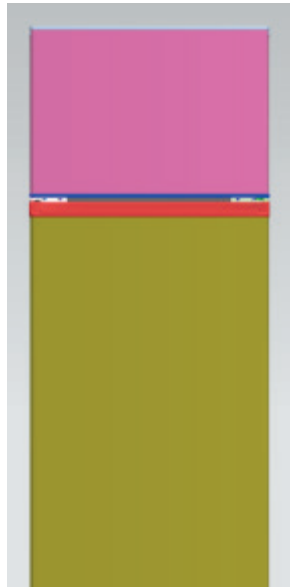

11) Install the four screw caps and two catches to corresponding position.

- Ensure the Appliance is unplugged and empty.
- Adjust the two leveling feet to their highest position.
- We recommend you have someone to assist you.

12) replace the leveler to the other side and adjust it to make sure the cabinet level.



*The picture above is only for reference. The actual configuration will depend on the physical product or statement by the distributor

2.3 Door Handle Install Illumination (optional)

Note: Figures in the user manual are only for reference. The actual product may differ slightly. The refrigerator must be disconnected from the source of electrical supply before attempting the installation of accessory.

Step 1: take out two plug pins from the door (Side of door open)



Step 2: Install the door handle to the door and fasten it with screws

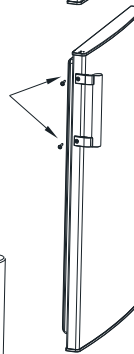
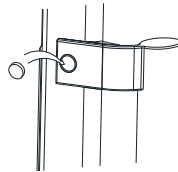

Step 3: Cover screw caps of the handle into screw holes

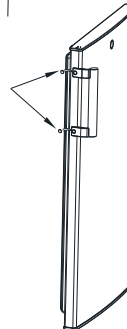

*The picture above is only for reference. The actual configuration will depend on the physical product or statement by the distributor

2.4 Door Space Requirements

The unit's door must be able to open fully as shown.

$W \times D \geq 902 \times 1052\text{mm}$

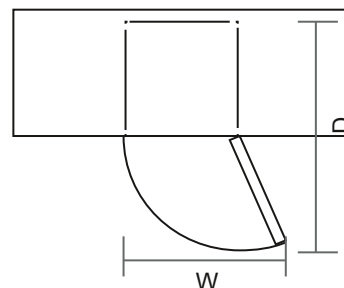

2.5 Levelling the Unit

To do this adjust the two levelling feet at the front of the unit.

If the unit is not level, the door and magnetic seal alignments will not be covered properly.

Make sure that the foot touches the ground before use.

Look down from the top, clockwise and counterclockwise loosening, tightening.

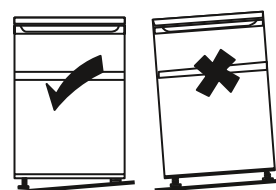

2.6 Cleaning Before Use

Wipe the inside of the unit with a weak solution of bicarbonate soda. Then rinse with warm water using a 'Wrung-out' sponge or cloth. Wash the shelves and salad bin in warm soapy water and dry completely before replacing in the unit. Clean the exterior of the unit with a damp cloth. If you require more information refer to the Cleaning section.

2.7 Before Using Your Unit

Do not damage the power cord under any condition so as to ensure safety use, do not use when the power cord is damaged or the plug is worn.

Do not put flammable, explosive, volatile and highly corrosive items in the refrigerator to prevent damages to the product or fire accidents.

Do not place flammable items near the refrigerator to avoid fires.

This product is household refrigerators and shall be only suitable for the storage of foods. According to national standards, household refrigerators shall not be used for other purposes, such as storage of blood, drugs or biological products.

Do not place items such as bottled or sealed container of fluid such as bottled beers and beverages in the freezer to prevent bursts and other losses.

Before placing any food in your unit, turn it on and wait for 24 hours, to make sure it is working properly and to allow it time to fall to the correct temperature. Your unit should not be overfilled.



◆ **Before Plugging in**

You must check that you have a socket which is compatible with the plug supplied with the unit.

◆ **Before Turning On!**

Do not turn on until two hours after moving the unit.

2.8 Interior Accessories

Various glass or plastic storage shelves are included with your appliance - different models have different combinations.

You should always slide one of the full size glass storage shelves into the lowest set of guides, above the fruit and vegetable containers, and keep it in this position. To do this, pull the storage shelf forward until it can be swivelled upwards or downwards and removed.

Please do the same in reverse to insert the shelf at a different height.



In order to make the most of the volume of the fresh food storage compartment and frozen-food storage compartment, the user can remove one or more shelves, drawers, out of the appliance, according to your daily use.

3. PRODUCT OVERVIEW

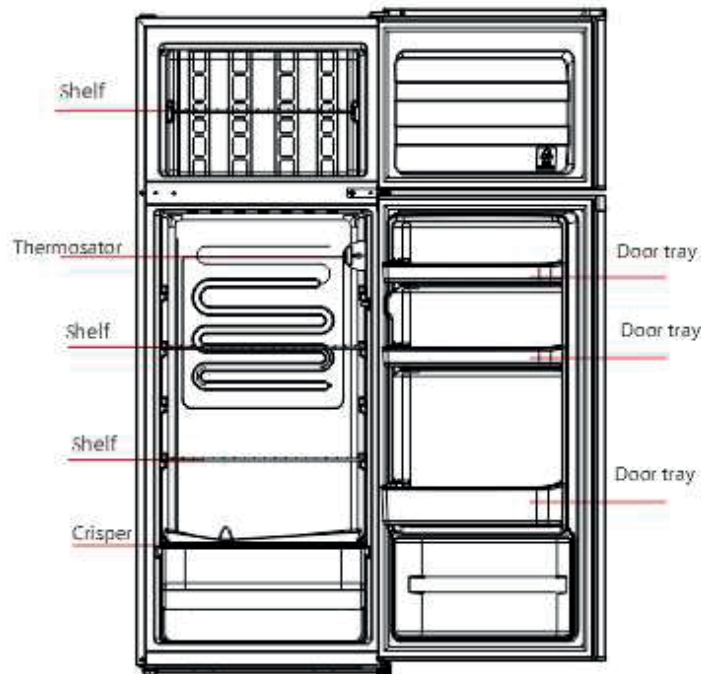

Drawers, food boxes, shelves, etc. placed according to the position in the picture above are the most energy efficient.

*The picture above is only for reference. The actual configuration will depend on the physical product or statement by the distributor

4. OPERATION

4.1 Switching On Your Unit

Setting “Off”: UnitOff

Setting “Min”: Less Cool Temperature

Setting “Med” or “MID”: Normal Operation(adequate for most situations)

Setting “Max”: Coolest Temperature

◆ During high ambient temperatures e.g. on hot summer days. It may be necessary to set the thermostat to the Coolest setting(position “Max”). This may cause the compressor running continuously in order to maintain a low temperature in the cabinet.

◆ For the first time you install your refrigerator, set the thermostat knob at “Med”.

Give your refrigerator time to cool down completely before adding food. It is the best to wait 24 hours before adding food. The thermostat knob controls the temperature. When the thermostat control knob is set to OFF, the refrigerator will not be running.

4.2 Noise Inside the Unit

You may notice that your unit makes some unusual noises. Most of these are perfectly normal, but you should be aware of them!

These noises are caused by the circulation of the refrigerant liquid in the cooling system. It has become more pronounced since the introduction of CFC free gases. This is not a fault and will not affect the performance of your unit. This is the compressor motor working, as it pumps the refrigerant around the system.

4.3 Tips for Keeping Food in the Unit

- ◆ Cooked meats/fishes should always be stored on a shelf above raw meats/fishes to avoid bacterial transfer. Keep raw meats/fishes in a container which is large enough to collect juices and cover it properly. Place the container on the lowest shelf.
- ◆ Leave space around your food, to allow air to circulate inside the unit. Ensure all parts of the unit are kept cool.
- ◆ To prevent transfer of favours and drying out, pack or cover the food separately. Fruit and vegetables do not need to be wrapped.
- ◆ Always let pre-cooked food cool down before you put in the unit. This will help to maintain the internal temperature of the unit.
- ◆ To prevent cold air escaping from the unit, try to limit the number of times you open the door. We recommend that you only open the door when you need to put food in or take food out.

4.4 Change the Light Bulb

Lamp replacement by professionals

5. CLEANING

5.1 Defrosting

NOTE THIS UNIT DOES NOT HAVE AN AUTO DEFROST SYSTEM.

Please use a plastic ice shovel when clearing the frosting of the evaporator. Do not use metal sharp objects.

5.2 Cleaning the Interior and the Exterior of the Unit

- ◆ Dusts behind the refrigerator and on the ground shall be timely cleaned to improve the cooling effect and energy saving.
- ◆ Check the door gasket regularly to make sure there are no debris. Clean the door gasket with a soft cloth dampened with soapy water or diluted detergent.
- ◆ The interior of the refrigerator should be cleaned regularly to avoid odor.
- ◆ Please turn off the power before cleaning interior, remove all foods, drinks ,shelves, drawers, etc.
- ◆ Use a soft cloth or sponge to clean the inside of the refrigerator, with two tablespoons of baking soda and a quart of warm water. Then rinse with water and wipe clean. After cleaning, open the door and let it dry naturally before turning on the power.
- ◆ For areas that are difficult to clean in the refrigerator (such as narrow sandwiches, gaps or corners), it is recommended to wipe them regularly with a soft rag, soft brush, etc. and when necessary, combined with some auxiliary tools (such as thin sticks) to ensure no contaminants or bacterials accumulation in these areas.
- ◆ Do not use soap, detergent, scrub powder, spray cleaner, etc., as these may cause odors in the interior of the refrigerator or contaminated food.
- ◆ Clean the bottle frame, shelves and drawers with a soft cloth dampened with soapy water or diluted detergent. Dry with a soft cloth or dry naturally.
- ◆ Wipe the outer surface of the refrigerator with a soft cloth dampened with soapy water, detergent, etc., and then wipe dry.
- ◆ Do not use hard brushes, clean steel balls, wire brushes, abrasives(such as toothpastes), organic solvents (such as alcohol, acetone, banana oil, etc.), boiling water, acid or alkaline items, which may damage the fridge surface and interior. Boiling water and organic solvents such as benzene may deform or damage plastic parts.
- ◆ Do not rinse directly with water or other liquids during cleaning to avoid short circuits or affect electrical insulation after immersion.

5.3 Cleaning Tips

Condensation may appear on the outside of the unit. This may be due to a change in room temperature. Wipe of any moisture residue. If the problem continues, please contact a qualified technician for assistance.

6. MAINTENANCE

6.1 Changing the Internal Light

Lamp replacement by professionals.

6.2 Care When Handling / Moving Your Unit

Hold the unit around its sides or base when moving it. Under no circumstances should it be lifted by holding the edges of the top surface.

6.3 Servicing

The unit should be serviced by an authorized engineer and only genuine spare parts should be used. Under no circumstances should you attempt to repair the unit yourself. Repairs carried out by inexperienced persons may cause injury or serious malfunction. Contact a qualitatively technician.

6.4 Switching Of for Long Periods of Time

When the unit is not in use for a long period of time, disconnect it from the mains supply, empty all food and clean the appliance, leaving the door ajar to prevent unpleasant smells.

7. Trouble shooting

The following simple issues can be handled by the user. Please call the after-sale service department if the issues are not settled.

Inoperation	Whether the freezer is plugged and connected to power; Low voltage; Failure power or tripping circuit
Odor	Odorous foods should closely wrapped; Whether foods are rotten; Whether the interior shall be cleaned.
Long-term operation of compressor	It is normal that refrigerator operates for longer time in summer when the ambient temperature is higher; Do not put too much food in the freezer at one time; Do not put foods until they are cooled; Frequent opening of refrigerator door.
Illuminating light does not shine	Whether the refrigerator is connected to power, whether the illuminating light is damaged.
The refrigerator door can not be properly closed.	The freezer door is stuck by food packages; Too much food; Tilt refrigerator.
Loud noises	Whether the food is leveled, whether the refrigerator is balanced; Whether the refrigerator parts are properly placed.

7.1 Warm tips:

- ◆The refrigerator enclosure may emit heat during operation specially in summer, this is caused by the radiation of the condenser, and it is a normal phenomenon.
- ◆Condensation: condensation phenomenon will be detected on the exterior surface and door seals of the freezer when the ambient humidity is large, this is a normal phenomenon, and the condensation can be wiped away with a dry towel.
- ◆Buzz: Buzz will be generated by running compressor specially when starting up or shutting down.

8. FOR ENERGY SAVING

Warning for energy

- 1) Refrigerating appliances might not operate consistently (possibility of defrosting of contents or temperature becoming too warm in the frozen food compartment) when sited for an extended period of time below the cold end of the range of temperatures for which the refrigerating appliance is designed.
- 2) The fact that effervescent drinks should not be stored in food freezer compartments or cabinets or in low-temperature compartments or cabinets, and that some products such as water ices should not be consumed too cold;
- 3) The need to not exceed the storage time(s) recommended by the food manufacturers for any kind of food and particularly for commercially quick-frozen food in food-freezer and frozen-food storage compartments or cabinets;
- 4) The precautions necessary to prevent an undue rise in the temperature of the frozen food while defrosting the refrigerating appliance, such as wrapping the frozen food in several layers of newspaper.
- 5) The fact that a rise in temperature of the frozen food during manual defrosting, maintenance or cleaning could shorten the storage life.

9. DISPOSAL

Old units still have some residual value. An environmentally friendly method of disposal will ensure that valuable raw materials can be recovered and used again. The refrigerant used in your unit and insulation materials require special disposal procedures. Ensure that none of the pipes on the back of the unit are damaged prior to disposal. Up to date information concerning options of disposing of your old unit and packaging from the new one can be obtained from your local council office.

When disposing of an old unit break of any old locks or latches and remove the door as a safeguard.

Correct Disposal of this product	
	<p>Correct Disposal of this product</p> <p>This marking indicates that this product should not be disposed with other household wastes throughout the EU. To prevent possible harm to the environment or human health from uncontrolled waste disposal, recycle it responsibly to promote the sustainable reuse of material resources. To return your used device, please use the return and collection systems or contact the retailer where the product was purchased. They can take this product for environmental safe recycling.</p>

For more information, please contact the local authority or your retailer where you purchased the product.

Table 1 Climate classes

Class	Symbol	Ambient temperature range °C
Extended temperate	SN	+ 10 to + 32
Temperate	N	+ 16 to + 32
Subtropical	ST	+ 16 to + 38
Tropical	T	+ 16 to + 43

Extended temperate: 'this refrigerating appliance is intended to be used at ambient temperatures ranging from 10 °C to 32 °C';

temperate: 'this refrigerating appliance is intended to be used at ambient temperatures ranging from 16 °C to 32 °C';

Subtropical: 'this refrigerating appliance is intended to be used at ambient temperatures ranging from 16 °C to 38 °C';

Tropical: 'this refrigerating appliance is intended to be used at ambient temperatures ranging from 16 °C to 43 °C';

The ordered parts in the following table can be acquired from channel INVENTOR:

Ordered Part	Provided by	Minimum Time Required for Provision
thermostats	Professional maintenance personnel	At least 7 years after the last model is launched on the market
temperature sensors	Professional maintenance personnel	At least 7 years after the last model is launched on the market
printed circuit boards	Professional maintenance personnel	At least 7 years after the last model is launched on the market
light sources	Professional maintenance personnel	At least 7 years after the last model is launched on the market
door handles	Professional repairers and final users	At least 7 years after the last model is launched on the market
door hinges	Professional repairers and final users	At least 7 years after the last model is launched on the market
trays	Professional repairers and final users	At least 7 years after the last model is launched on the market
baskets	Professional repairers and final users	At least 7 years after the last model is launched on the market
door gaskets	Professional repairers and final users	At least 10 years after the last model is launched on the market

Activate your Warranty

- Visit our web site and activate your warranty via the below link or by scanning the QR code

<https://www.inventorairconditioner.com/warranty-inventor>



- Fill all the fields as shown below

To activate the warranty card, please fill in the following fields

Owner details	Unit details
Full Name* <input type="text"/>	Unit Type* <input type="text"/>
Address* <input type="text"/>	Serial Number of the unit* <input type="text"/>
Postal Code* <input type="text"/>	Date of Purchase* <input type="text"/>
Phone Number* <input type="text"/>	Invoice Number* <input type="text"/>
E-mail* <input type="text"/>	Additional Details <input type="text"/>

Subscribe to Inventor's Newsletter

* Required field
With the current warranty card you accept the terms and conditions.

- once the warranty submission has been completed a confirmation message will be sent to your email

Περιεχόμενα

1.	ΟΔΗΓΙΕΣ ΑΣΦΑΛΕΙΑΣ	1
2.	ΕΓΚΑΤΑΣΤΑΣΗ	3
2.1	Τοποθέτηση	3
2.2	Απαιτούμενος χώρος για την πόρτα	3
2.3	Ισοστάθμιση του ψυγείου	3
2.4	Καθαρισμός πριν την χρήση	3
2.5	Πριν χρησιμοποιήσετε το ψυγείο	4
2.6	Εσωτερικά εξαρτήματα	4
3.	ΠΑΡΟΥΣΙΑΣΗ ΠΡΟΪΟΝΤΟΣ	5
4.	ΛΕΙΤΟΥΡΓΙΑ	5
4.1	Ενεργοποίηση του ψυγείου	5
4.2	Θόρυβος εντός του ψυγείου	6
4.3	Συμβουλές αποθήκευσης τροφίμων στο ψυγείο	6
4.4	Αντικατάσταση της λυχνίας φωτισμού	6
5.	ΚΑΘΑΡΙΣΜΟΣ	6
5.1	Καθαρισμός του εσωτερικού και εξωτερικού του ψυγείου	6
5.2	Συμβουλές σχετικά με τον καθαρισμό	7
6.	ΣΥΝΤΗΡΗΣΗ	7
6.1	Αντικατάσταση της λυχνίας φωτισμού στο εσωτερικό του ψυγείου	7
6.2	Οδηγίες για την μεταφορά / αλλαγή θέσης του ψυγείου	7
6.3	Επισκευές	7
6.4	Απενεργοποίηση του ψυγείου για αρκετό χρονικό διάστημα	7
6.5	Οδηγίες τοποθέτησης της πόρτας δεξιά και αριστερά.....	7
7.	Αντιμετώπιση προβλημάτων	10
7.1	Συμβουλές	10
8.	ΣΥΜΒΟΥΛΕΣ ΓΙΑ ΕΞΟΙΚΟΝΟΜΗΣΗ ΕΝΕΡΓΕΙΑΣ	11
9.	ΑΠΟΡΡΙΨΗ ΤΟΥ ΠΡΟΪΟΝΤΟΣ	11



Προειδοποίηση:

κίνδυνος πυρκαγιάς /
εύφλεκτων υλικών

Αυτή η συσκευή προορίζεται για χρήση σε οικιακές και παρόμοιες εφαρμογές, όπως -κουζίνα προσωπικού σε καταστήματα, γραφεία και άλλα περιβάλλοντα- αγροικίες και πελάτες σε ξενοδοχεία, μοτέλ και άλλα περιβάλλοντα τύπου κατοικίας - περιβάλλοντα τύπου πανδοχείου (bed & breakfast), τροφοδοσία και παρόμοιες εφαρμογές μη λιανικής πώλησης.

Εάν το καλώδιο τροφοδοσίας είναι φθαρμένο, πρέπει να αντικατασταθεί από τον κατασκευαστή ή το εξουσιοδοτημένο κατάστημα τεχνικής υποστήριξης ή από άτομα με παρόμοια ειδικευση, προκειμένου να αποφευχθούν τυχόν κίνδυνοι.

Μην αποθηκεύετε σε αυτή τη συσκευή εκρηκτικές ουσίες όπως αεροζόλ με εύφλεκτο προωθητικό αέριο.

Η συσκευή πρέπει να αποσυνδεθεί μετά τη χρήση και πριν από τη συντήρηση του χρήστη.

ΠΡΟΕΙΔΟΠΟΙΗΣΗ: Διατηρείτε ελεύθερες τις οπές εξαερισμού, στο περίβλημα της συσκευής ή στην ενσωματωμένη δομή της, απομακρύνοντας τυχόν εμπόδια.

ΠΡΟΕΙΔΟΠΟΙΗΣΗ: Μη χρησιμοποιείτε μηχανικές συσκευές ή άλλα μέσα για να επιταχύνετε τη διαδικασία απόψυξης, εκτός από εκείνες που συνιστώνται από τον κατασκευαστή.

ΠΡΟΕΙΔΟΠΟΙΗΣΗ: Μην προκαλείτε φθορές στο κύκλωμα ψυκτικού μέσου.

ΠΡΟΕΙΔΟΠΟΙΗΣΗ: Μην χρησιμοποιείτε ηλεκτρικές συσκευές μέσα στα διαμερίσματα αποθήκευσης τροφίμων της συσκευής, εκτός αν είναι του τύπου που συνιστάται από τον κατασκευαστή.

ΠΡΟΕΙΔΟΠΟΙΗΣΗ: Παρακαλείστε να απορρίψετε το ψυγείο σύμφωνα με τους τοπικούς κανονισμούς σχετικά με την διάθεση της συσκευής λόγω του εύφλεκτου αερίου εμφύσησης και του ψυκτικού μέσου.

ΠΡΟΕΙΔΟΠΟΙΗΣΗ: Κατά την τοποθέτηση της συσκευής, βεβαιωθείτε ότι το καλώδιο τροφοδοσίας δεν έχει παγιδευτεί ή έχει υποστεί φθορά.

ΠΡΟΕΙΔΟΠΟΙΗΣΗ: Μην τοποθετείτε πολλές φορητές πρίζες ή φορητές παροχές τροφοδοσίας στο πίσω μέρος της συσκευής.

Μην χρησιμοποιείτε καλώδια επέκτασης ή μη γειωμένους αντάπτορες (δύο ακίδων).

ΚΙΝΔΥΝΟΣ: Κίνδυνος παγίδευσης παιδιών. Πριν πετάξετε το παλιό ψυγείο ή τον καταψύκτη σας:

- Αφαιρέστε τις πόρτες.
- Αφήστε τα ράφια στη θέση τους, ώστε τα παιδιά να μην μπορούν να ανέβουν εύκολα μέσα.

Το ψυγείο πρέπει να αποσυνδεθεί από την πηγή ηλεκτρικής τροφοδοσίας πριν από την εγκατάσταση εξαρτήματος.

Το ψυκτικό μέσο και το υλικό αφρισμού κυκλοπεντανίου που χρησιμοποιείται για το ψυγείο είναι εύφλεκτα. Επομένως, όταν το ψυγείο διαλυθεί, πρέπει να απομακρυνθεί από οποιαδήποτε πηγή φωτιάς και να ανακυκλωθεί από μια ειδική εταιρεία ανάκτησης με αντίστοιχη πιστοποίηση διαφορετική από την απόρριψη με καύση, ώστε να αποφευχθεί η πρόκληση βλάβης στο περιβάλλον ή οποιαδήποτε άλλη βλάβη.

Κατά το πρότυπο EN: Αυτή η συσκευή μπορεί να χρησιμοποιηθεί από παιδιά ηλικίας από 8 ετών και άνω και άτομα με μειωμένες φυσικές αισθητικές ή διανοητικές ικανότητες ή έλλειψη εμπειρίας και γνώσης, εάν έχουν επίβλεψη ή οδηγίες σχετικά με τη χρήση της συσκευής με ασφαλή τρόπο και κατανοούν τους εμπλεκόμενους κινδύνους. Τα παιδιά δεν πρέπει να παίζουν με τη συσκευή. Ο καθαρισμός και η συντήρηση από τον χρήστη δεν πρέπει να πραγματοποιούνται από παιδιά χωρίς επίβλεψη. Τα παιδιά ηλικίας από 3 έως 8 ετών επιτρέπεται να φορτώνουν και να ξεφορτώνουν ψυκτικές συσκευές.

Κατά το πρότυπο IEC: Αυτή η συσκευή δεν προορίζεται για χρήση από άτομα (συμπεριλαμβανομένων παιδιών) με μειωμένες σωματικές, αισθητηριακές ή διανοητικές ικανότητες ή έλλειψη εμπειρίας και γνώσης, εκτός εάν έχουν επίβλεψη ή οδηγίες σχετικά με τη χρήση της συσκευής από άτομο υπεύθυνο για την ασφάλειά τους.

Τα παιδιά θα πρέπει να επιβλέπονται για να διασφαλιστεί ότι δεν παίζουν με τη συσκευή.

ΓΙΑ να αποφύγετε τη μόλυνση των τροφίμων, τηρήστε τις παρακάτω οδηγίες:

- Η ανοιγόμενη πόρτα για μεγάλες περιόδους μπορεί να προκαλέσει σημαντική αύξηση της θερμοκρασίας στα διαμερίσματα της συσκευής.

- Να καθαρίζετε τακτικά επιφάνειες που μπορούν να έρθουν σε επαφή με τρόφιμα και προσβάσιμα συστήματα αποστράγγισης.

- Δεξαμενές καθαρού νερού εάν δεν έχουν χρησιμοποιηθεί για 48 ώρες. Ξεπλύνετε το σύστημα ύδρευσης που είναι συνδεδεμένο με παροχή νερού εάν δεν έχει τραβηχτεί νερό για 5 ημέρες.. (σημείωση 1)

- Φυλάξτε το ωμό κρέας και τα ψάρια σε κατάλληλα δοχεία στο ψυγείο, έτσι ώστε να μην έρχονται σε επαφή ή να μην στάζουν σε άλλα τρόφιμα.

- Διαμερίσματα ****** κατεψυγμένου φαγητού δύο αστέρων είναι κατάλληλα για την αποθήκευση των προ-καταψυγμένων τροφίμων, την αποθήκευση ή την παρασκευή παγωτού και την κατασκευή παγοκύβων. (σημείωση 2)

-Του ενός ***** -,των δύο ****** -και τα τριών ******* αστέρων διαμερίσματα δεν είναι κατάλληλα για την κατάψυξη των νωπών τροφίμων. (σημείωση 3)

- Αν η ψυκτική συσκευή παραμείνει άδεια για μεγάλες χρονικές περιόδους, απενεργοποιήστε, ξεπαγώστε, καθαρίστε, στεγνώστε και αφήστε την πόρτα ανοικτή για να αποφύγετε την ανάπτυξη μούχλας μέσα στη συσκευή.

- Για συσκευές χωρίς 4 - αστέρων διαμέρισμα: η παρούσα συσκευή κατάψυξης δεν είναι κατάλληλη για την κατάψυξη τροφίμων υλικών. (σημείωση 4)

Σημείωση 1,2,3,4: Παρακαλείστε να επιβεβαιώσετε αν ισχύει ανάλογα με το είδος του διαμερισμάτος σας.

ΓΙΑ μία ανεξάρτητη συσκευή: η παρούσα συσκευή κατάψυξης δεν προορίζεται να χρησιμοποιηθεί σαν μία εντοιχισμένη - συσκευή.

Η ανάγκη να παραμείνουν τα κλειδιά για τις πόρτες ή τα καλύμματα που διαθέτουν κλειδαριές και κλειδιά μακριά από τα παιδιά και όχι κοντά στη συσκευή ψύξης, προκειμένου να αποφευχθεί το κλείδωμα των παιδιών στο εσωτερικό τους.

2. ΕΓΚΑΤΑΣΤΑΣΗ

2.1 Τοποθέτηση

Κατά την επιλογή της θέσης, βεβαιωθείτε πως το δάπεδο είναι επίπεδο και σταθερό και πως ο χώρος αερίζεται επαρκώς με μια μέση θερμοκρασία 16°C-43°C. Μην τοποθετείτε το ψυγείο κοντά σε πηγές θερμότητας. Επιπλέον, αποφύγετε την απευθείας έκθεση στην ηλιακή ακτινοβολία διότι μπορεί να αυξηθεί η κατανάλωση ενέργειας. Ακραίες χαμηλές εξωτερικές θερμοκρασίες μπορεί να προκαλέσουν μη ομαλή λειτουργία του ψυγείου. Αυτή η συσκευή δεν είναι σχεδιασμένη για χρήση σε γκαραζ ή για εξωτερική χρήση. Μην καλύπτετε το ψυγείο.

Κατά την εγκατάσταση του ψυγείου, βεβαιωθείτε πως υπάρχει ελεύθερος χώρος τουλάχιστον 10cm και απο τις 2 πλαϊνές πλευρές, 10cm από την πίσω πλευρά και 30cm από την πάνω πλευρά. Έτσι επιτυγχάνεται η καλύτερη κυκλοφορία του κρύου αέρα και βελτιώνεται η απόδοση της διαδικασίας ψύξης.

2.2 Απαιτούμενος χώρος για την πόρτα

Η πόρτα του ψυγείου θα πρέπει να μπορεί να ανοιχτεί τελείως.

$\Pi \times B \geq 1180 \times 1150\text{mm}$

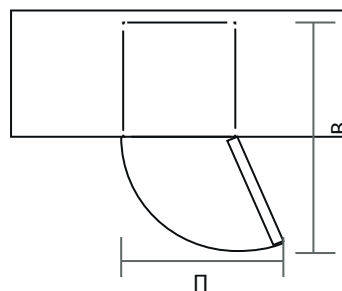

2.3 Ισοστάθμιση του ψυγείου

Ρυθμίστε τα πόδια στήριξης. Εάν η μονάδα δεν είναι σταθμισμένη, η πόρτες δεν θα κλείνουν σωστά.

Πριν τη χρήση βεβαιωθείτε πως τα πόδια είναι σταθερά στο δάπεδο.

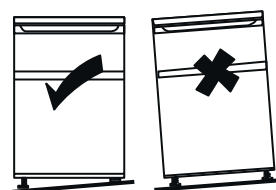

2.4 Καθαρισμός πριν τη χρήση

Καθαρίστε το εσωτερικό του ψυγείου αρχικά με διάλυμα σόδας και έπειτα σκουπίστε με ένα μαλακό πανί που έχετε ξεβγάλει σε ζεστό νερό. Καθαρίστε τα ράφια και το συρτάρι με ζεστό σαπουνοδιάλυμα και αφήστε τα να στεγνώσουν πριν τα επανατοποθετήσετε στο ψυγείο. Καθαρίστε το εξωτερικό μέρος του ψυγείου με υγρό πανί. Για περισσότερες πληροφορίες ανατρέξτε στο εδάφιο που αναφέρεται στον καθαρισμό.

2.5 Πριν χρησιμοποιήσετε το ψυγείο

Βεβαιωθείτε πως δεν είναι φθαρμένο το καλώδιο τροφοδοσίας και μην χρησιμοποιείτε το ψυγείο αν το καλώδιο τροφοδοσίας ή η πρίζα είναι φθαρμένα.

Μην τοποθετείτε εύφλεκτα, εκρηκτικά, ασταθή και διαβρωτικά αντικείμενα μέσα στο ψυγείο, για την αποφυγή βλάβης του ψυγείου ή πυρκαγιάς.

Μην τοποθετείτε εύφλεκτα υλικά κοντά στο ψυγείο, για την αποφυγή πυρκαγιάς.

Αυτό το προϊόν είναι ψυγείο οικιακής χρήσης και πρέπει να χρησιμοποιείται μόνο για την αποθήκευση τροφίμων. Σύμφωνα με τους εθνικούς κανονισμούς τα οικιακής χρήσης ψυγεία δεν πρέπει να χρησιμοποιούνται για άλλους σκοπούς όπως αποθήκευση αίματος, φαρμάκων ή βιολογικών προϊόντων.

Μην τοποθετείτε στην κατάψυξη του ψυγείου υγρά σφραγισμένα ή σε μπουκάλια, όπως μπίρες και αναψυκτικά, για την αποφυγή σπασίματος ή άλλων απωλειών.

Πριν τοποθετήσετε τρόφιμα στο ψυγείο, αφήστε το να λειτουργήσει άδειο για 24 ώρες ώστε να βεβαιωθείτε πως λειτουργεί σωστά και η θερμοκρασία στο εσωτερικό να φτάσει στην κατάλληλη. Δεν πρέπει να τοποθετείτε υπερβολική ποσότητα τροφίμων στο ψυγείο.



■ Πριν συνδέσετε το ψυγείο με την παροχή ρεύματος

Βεβαιωθείτε πως υπάρχει πρίζα που να ταιριάζει με το φις του ψυγείου.

■ Πριν ενεργοποιήσετε το ψυγείο

Ενεργοποιήστε το ψυγείο τουλάχιστον 2 ώρες μετά από την μετακίνηση του.

2.6 Εσωτερικά Εξαρτήματα

Στην συσκευή περιλαμβάνονται γυάλινα ή πλαστικά ράφια ανάλογα το μοντέλο.

Να τοποθετείτε το ένα από τα γυάλινα ράφια πάντα στην χαμηλότερη θέση, πάνω από τον χώρο αποθήκευσης των φρούτων και λαχανικών. Για να το κάνετε αυτό, τραβήξτε το ράφι προς τα εμπρός μέχρι να μπορεί να κινηθεί προς τα πάνω ή προς τα κάτω και αφαιρέστε το.

Για να τοποθετήσετε το ράφι σε άλλο ύψος, επαναλάβετε αντίστροφα τη διαδικασία.



Για να αυξήσετε τον χώρο στον θάλαμο του ψυγείου ή της κατάψυξης, μπορείτε να αφαιρέσετε ένα ή περισσότερα ράφια ή συρτάρια ανάλογα με την καθημερινή χρήση.

3. ΠΑΡΟΥΣΙΑΣΗ ΠΡΟΪΟΝΤΟΣ

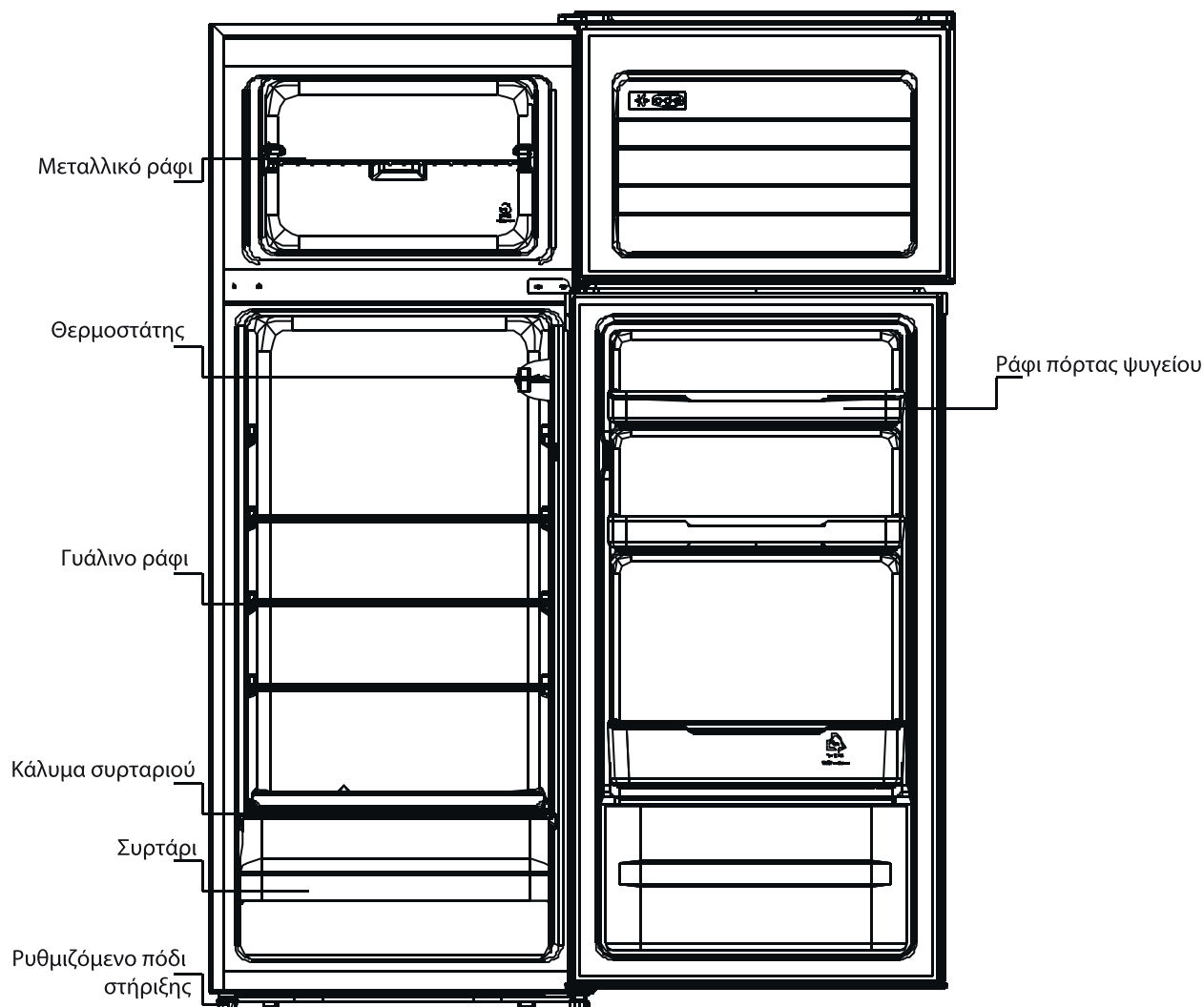

* Οι εικόνες σε αυτό το εγχειρίδιο είναι αναφορικές. Για λεπτομέρειες ανατρέξτε στο ψυγείο που έχετε προμηθευτεί.

4. ΛΕΙΤΟΥΡΓΙΑ

4.1 Ενεργοποίηση του ψυγείου

- Ο θερμοστάτης είναι τοποθετημένος στην δεξιά πλευρά του εσωτερικού μέρους του ψυγείου
Επιλογή "off": Το ψυγείο δεν λειτουργεί
Επιλογή "Min": Μικρότερη επιλογή ψύξης
Επιλογή "Med": Συνήθης λειτουργία (κατάλληλη για τις περισσότερες περιπτώσεις)
Επιλογή "Max": Μέγιστη επιλογή ψύξης
- Στις περιόδους με υψηλή θερμοκρασία περιβάλλοντος π.χ. τις ζεστές μέρες του καλοκαιριού, μπορεί να χρειαστεί να θέσετε τον θερμοστάτη στην μέγιστη ρύθμιση. Αυτό θα έχει ως αποτέλεσμα τη συνεχή λειτουργία του συμπιεστή ώστε να διατηρείται η χαμηλή θερμοκρασία στον θάλαμο.

- Κατά την πρώτη εκκίνηση λειτουργίας του ψυγείου σας, θέστε τον θερμοστάτη στη θέση Med. Αφήστε το ψυγείο να λειτουργεί για 24 ώρες πριν τοποθετήσετε τρόφιμα στους θαλάμους. Ο θερμοστάτης ελέγχει τη θερμοκρασία. Όταν ο θερμοστάτης είναι σε θέση OFF, το ψυγείο δεν θα λειτουργεί

4.2 Θόρυβος εντός του ψυγείου!

Μπορεί να ακούσετε κάποιους ασυνήθιστους θορύβους από το ψυγείο. Οι περισσότεροι από αυτούς είναι φυσιολογικοί αλλά θα πρέπει να δίνετε ιδιαίτερη προσοχή.

Αυτοί οι θόρυβοι προκαλούνται από την κυκλοφορία του ψυκτικού υγρού στο ψυκτικό κύκλωμα. Έχουν διαπιστωθεί ακόμα περισσότερο από τότε που εισήλθαν τα αέρια CFC. Δεν αποτελεί σφάλμα και δεν επηρεάζει την απόδοση του ψυγείου. Είναι η λειτουργία του συμπιεστή, καθώς αντλεί το ψυκτικό υγρό στο κύκλωμα.

4.3 Συμβουλές αποθήκευσης τροφίμων στο ψυγείο

- Τα μαγειρεμένα κρέατα/ψάρια θα πρέπει να αποθηκεύονται σε ένα ράφι πάνω από ωμά κρέατα/ψάρια για την αποφυγή μεταφοράς βακτηριδίων. Τοποθετήστε τα ωμά κρέατα/ψάρια σε ένα δοχείο αρκετά μεγάλο ώστε να συλλέγονται τα υγρά και καλύψτε το κατάλληλα.
- Τοποθετήστε το δοχείο στο χαμηλότερο ράφι.
- Να αφήνετε χώρο γύρω από τα τρόφιμα, ώστε να επιτρέπεται στον αέρα να κυκλοφορεί στο εσωτερικό του ψυγείου. Βεβαιωθείτε πως όλα τα μέρη του ψυγείου είναι κρύα.
- Για την αποφυγή μεταφοράς οσμών, συσκευάστε ξεχωριστά τα τρόφιμα. Τα φρούτα και τα λαχανικά δεν χρειάζεται να τα συσκευάσετε.
- Πριν τοποθετήσετε μαγειρεμένα τρόφιμα στο ψυγείο αφήστε τα να κρυώσουν πρώτα. Αυτό θα βοηθήσει να διατηρηθεί η θερμοκρασία στο εσωτερικό του ψυγείου. Για να μην διαφύγει κρύος αέρας από το ψυγείο, προσπαθήστε να μην ανοίγετε πολλές φορές την πόρτα. Συστήνεται να ανοίγετε την πόρτα όταν χρειάζεται να βγάλετε ή να βάλετε τρόφιμα στο ψυγείο.

4.4 Αντικατάσταση λυχνίας φωτισμού

Η αντικατάσταση γίνεται από επαγγελματίες.

5. ΚΑΘΑΡΙΣΜΟΣ

5.1 Καθαρισμός του εσωτερικού και του εξωτερικού μέρους του ψυγείου

- Αφαιρέστε όλα τα ράφια και το συρτάρι. Για να αφαιρέσετε το συρτάρι αφαιρέστε πρώτα το χαμηλότερο ράφι της πόρτας.
- Καθαρίστε το εσωτερικό του ψυγείου με ένα διάλυμα σόδας και έπειτα με ένα πανί και ζεστό νερό. Βαβαιωθείτε πως έχει στεγνώσει το εσωτερικό πριν επανατοποθετήσετε τα ράφια και το συρτάρι.
- Καθαρίστε το εξωτερικό μέρος με ένα βρεγμένο πανί και έπειτα σκουπίστε με ένα κοινό γυαλιστικό επίπλων. Βεβαιωθείτε πως η πόρτα του ψυγείου είναι κλειστή για την αποφυγή εισόδου του γυαλιστικού στο εσωτερικό του ψυγείου.
- Η γρίλια του συμπυκνωτή στο πίσω μέρος του ψυγείου καθώς και όλα τα παρελκόμενα μπορούν να καθαριστούν με μια μαλακή βούρτσα.

5.2 Συμβουλές για τον καθαρισμό

Μπορεί να εμφανιστούν συμπυκνώματα στο εξωτερικό του ψυγείου. Μπορεί να αφείλεται σε αλλαγή της θερμοκρασίας του χώρου. Απλά σκουπίστε τα. Εάν το πρόβλημα παραμένει, επικοινωνήστε με εξειδικευμένο τεχνικό για να σας βοηθήσει.

6. ΣΥΝΤΗΡΗΣΗ

6.1 Αντικατάσταση λυχνίας εσωτερικού φωτισμού

Η αντικατάσταση πρέπει να γίνει από επαγγελματία

6.2 Οδηγίες για την μεταφορά / αλλαγή θέσης του ψυγείου

Κατά την μετακίνηση κρατήστε το ψυγείο από τις πλαϊνές πλευρές ή από τη βάση του. Σε καμία περίπτωση δεν πρέπει να ανασηκωθεί από τα άκρα του επάνω μέρους του.

6.3 Επισκευές

Οι εργασίες επισκευής πρέπει να γίνονται από εξειδικευμένο τεχνικό.

6.4 Απενεργοποίηση του ψυγείου για αρκετό χρονικό διάστημα.

Όταν δεν θα χρησιμοποιήσετε το ψυγείο για αρκετό χρονικό διάστημα, αποσυνδέστε το από την παροχή ρεύματος, αδειάστε το, καθαρίστε το και αφήστε την πόρτα μισάνοιχτη για την αποφυγή δημιουργίας οσμών.

6.5 Οδηγίες τοποθέτησης της πόρτας δεξιά και αριστερά

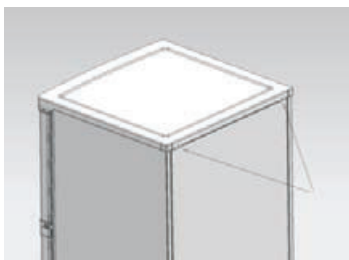

1. Αφαιρέστε τις 2 βίδες που βρίσκονται στο πάνω κάλυμα και αφαιρέστε το.



2. Αφαιρέστε τις 2 βίδες που βρίσκονται πάνω στον μεντεσέ

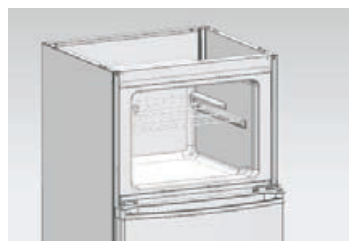

3. Αφαιρέστε την πόρτα



4. Αφαιρέστε τις 2 βίδες για να αφαιρέσετε τον μεντεσέ και αφαιρέστε την πόρτα.

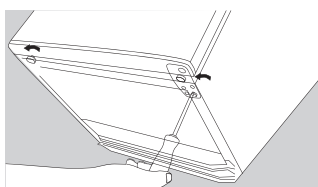

5. Ξεβιδώστε τις βίδες και αφαιρέστε τον βραχίονα του μεντεσέ από τη βάση. Μπορεί να χρειαστεί γαλλικό κλειδί για να χαλαρώσετε τις βίδες. Αφαιρέστε την ακίδα του μεντεσέ και τοποθετήστε την στην απέναντι πλευρά.

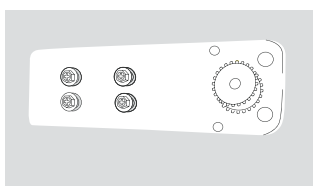

Μετακινείστε τις βίδες και την βάση από την αντίθετη πλευρά και τοποθετήστε τις στο σημείο που βρισκόταν ο μεντεσές.

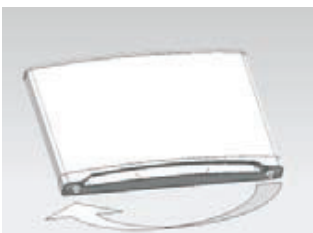

6. Θα γίνει αλλαγή και στο κάτω μέρος της πόρτας από την μια πλευρά στην άλλη.

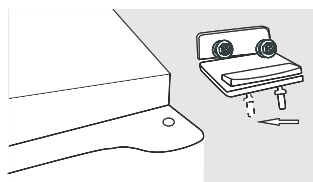

7. Αφαιρέστε την ακίδα της δεξιάς οπής στον πάνω μεντεσέ και τοποθετήστε τη στην αριστερή οπή, όπως δείχνει το βέλος.

8. Αφαιρέστε το κυλινδρικό κάλυμα από την πλευρά που έγινε η αλλαγή και τοποθετήστε το στην άλλη.

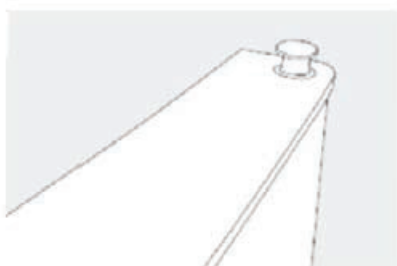

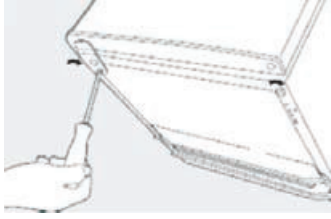

9. Τοποθετήστε τον μεντεσέ στην άλλη πλευρά και σφίξτε τη βίδα



10. Τοποθετήστε τον μεντεσέ της πόρτας και σφίξτε τις βίδες

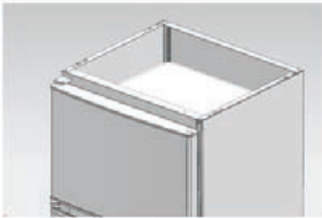

11. Τοποθετήστε την πόρτα και τον μεντεσέ και σφίξτε τις βίδες

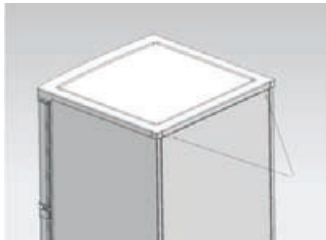

12. Τοποθετήστε το κάλυμα

7. Αντιμετώπιση προβλημάτων

Τα παρακάτω απλά θέματα μπορούν να επιλυθούν από τον χρήστη. Εάν τα προβλήματα παραμείνουν επικοινωνήστε με τον προμηθευτή σας.

Το ψυγείο δεν λειτουργεί	Ελέγξτε εάν ο καταψύκτης είναι συνδεδεμένος με την παροχή ρεύματος. Χαμηλή τάση. Ελέγξτε ότι ο θερμοστάτης βρίσκεται εντός του εύρους λειτουργίας. Διακοπή ρεύματος ή έχει ενεργοποιηθεί ασφάλεια στο κύκλωμα
Οσμές	Τα τρόφιμα με έντονη οσμή, θα πρέπει να τυλίγονται επαρκώς. Ελέγξτε μήπως υπάρχει χαλασμένο τρόφιμο. Ελέγξτε μήπως το εσωτερικό του ψυγείου χρειάζεται καθαρισμό.
Ο συμπιεστής λειτουργεί συνεχώς	Κατά τη διάρκεια του καλοκαιριού είναι φυσιολογικό ο συμπιεστής να λειτουργεί περισσότερο λόγω της υψηλότερης θερμοκρασίας περιβάλλοντος. Μην τοποθετείτε πολλά τρόφιμα στο ψυγείο. Μην τοποθετείτε στο ψυγείο ζεστά τρόφιμα. Μην ανοίγετε συχνά την πόρτα του ψυγείου.
Η ενδυκτική λυχνία δεν ανάβει	Ελέγξτε εάν το ψυγείο είναι συνδεδεμένο με την παροχή ρεύματος ή αν η ενδεικτική λυχνία έχει καεί.
Η πόρτα του ψυγείου δεν κλείνει σωστά	Η πόρτα έχει φράξει από συσκευασίες τροφίμων. Υπάρχει υπερβολική ποσότητα τροφίμων. Το ψυγείο γέρνει.
Δυνατοί θόρυβοι	Ελέγξτε εάν τα τρόφιμα έχουν τοποθετηθεί σωστά. Ελέγξτε εάν το ψυγείο είναι σε επίπεδο έδαφος Ελέγξτε αν τα επιμέρους εξαρτήματα έχουν τοποθετηθεί σωστά.

7.1 Συμβουλές:

- Μπορεί να εκλύεται θερμότητα από το ψυγείο κατά τη λειτουργία ειδικά το καλοκαίρι. Οφείλεται στην εκπομπή θερμότητας του συμπυκνωτή και είναι φυσιολογικό.
- Συμπυκνώματα: Όταν υπάρχει υψηλή σχετική υγρασία μπορεί να εμφανιστούν συμπυκνώματα στην εξωτερική επιφάνεια και στην πόρτα. Είναι φυσιολογικό και μπορείτε απλά να τα απομακρύνετε με ένα στεγνό πανί.
- Κατά την ενεργοποίηση και απενεργοποίηση του συμπιεστή αλλά και κατά τη λειτουργία θα ακούγεται ένας συνεχόμενος ήχος.

8. ΣΥΜΒΟΥΛΕΣ ΓΙΑ ΕΞΟΙΚΟΝΟΜΗΣΗ ΕΝΕΡΓΕΙΑΣ

Προσπαθήστε να μην ανοίγετε συχνά την πόρτα του ψυγείου ειδικά όταν ο καιρός είναι υγρός και ζεστός. Εφόσον ανοίξετε την πόρτα κλείστε την αμέσως.

Να ελέγχετε περιοδικά εάν υπάρχει επαρκής κυκλοφορία του αέρα στο πίσω μέρος του ψυγείου. Σε ομαλές συνθήκες θερμοκρασίας να θέτετε τον θερμοστάτη στη θέση "Med".

Πριν τοποθετήσετε τρόφιμα στο ψυγείο βεβαιωθείτε πως δεν είναι ζεστά.

Ο πάγος που σχηματίζεται αυξάνει την κατανάλωση ενέργειας. Να καθαρίζετε το ψυγείο όταν το στρώμα πάγου φτάσει τα 3-5mm.

Ο χώρος πίσω από το ψυγείο θα πρέπει να είναι πάντα καθαρός.

- Το ψυγείο θα πρέπει να τοποθετείται σε δροσερό μέρος, μακριά από πηγές θερμότητας και από την ηλιακή ακτινοβολία.
- Μην τοποθετείτε ζεστά τρόφιμα στο ψυγείο. Υπερβολική ποσότητα τροφίμων έχει ως αποτέλεσμα τη συνεχή λειτουργία του συμπιεστή, τα τρόφιμα δεν θα παγώνουν και μπορεί να χαλάσουν.
- Βεβαιωθείτε πως έχετε συσκευάσει κατάλληλα τα τρόφιμα και σκουπίστε τα δοχεία αποθήκευσης πριν τα τοποθετήσετε στο ψυγείο. Με αυτόν το τρόπο μειώνεται ο σχηματισμός πάγου στο εσωτερικό του ψυγείου.
- Μην καλύπτετε τους αποθηκευτικούς χώρους του ψυγείου με αλουμινοχαρτο, χαρτί ή πετσέτες, μειώνεται η απόδοση του ψυγείου.
- Τοποθετήστε τα τρόφιμα με μια λογική σειρά και τοποθετήστε ετικέτες ώστε να αποφύγετε τα συχνά ανοίγματα της πόρτας. Όταν ανοίγετε την πόρτα φροντίστε να πάρετε όσα πράγματα χρειάζεστε και κλείστε την πόρτα όσο πιο γρήγορα γίνεται.

9. ΑΠΟΡΡΙΨΗ

Οι παλιές συσκευές έχουν κάποια αξία. Με μια μέθοδο απόρριψης φιλικής προς το περιβάλλον όλα τα πολύτιμα υλικά μπορούν να ανακτηθούν και να επαναχρησιμοποιηθούν. Το ψυκτικό υγρό και τα μονωτικά υλικά χρειάζονται ειδικές διαδικασίες απόρριψης. Βεβαιωθείτε πως οι σωληνώσεις που βρίσκονται στο πίσω μέρος του ψυγείου δεν έχουν φθαρεί. Για περισσότερες πληροφορίες σχετικά με την απόρριψη της παλιάς σας συσκευής καθώς και της συσκευασίας της νέας σας συσκευής, μπορείτε να απευθυνθείτε στις τοπικές αρχές.

Πριν απορρίψετε ένα παλιό ψυγείο αφαιρέστε τυχόν κλειδαρίες και την πόρτα.

Σωστή απόρριψη του συγκεκριμένου προϊόντος



Αυτό το σύμβολο υποδεικνύει πως αυτό το προϊόν δεν πρέπει να απορρίπτεται μαζί με τα αστικά λύματα. Για την προστασία του περιβάλλοντος και την ανθρώπινη υγεία, να ανακυκλώνετε αυτά τα προϊόντα. Για περισσότερες πληροφορίες σε ότι αφορά την ανακύκλωση μπορείτε να απευθυνθείτε σε ειδικούς οργανισμούς ή επικοινωνήστε με τον προμηθευτή σας. Έχουν τη δυνατότητα να παραλάβουν αυτό το προϊόν προς ανακύκλωση.

Για περισσότερες πληροφορίες επικοινωνήστε με τις τοπικές αρχές ή με τον προμηθευτή σας.

Table 1 Climate classes

Class	Symbol	Ambient temperature range °C
Sub Normal	SN	+ 10 to + 32
Normal	N	+ 16 to + 32
Subtropical	ST	+ 16 to + 38
Tropical	T	+ 16 to + 43

Εκτεταμένη εύκρατη: 'η συγκεκριμένη συσκευή ψύξης προορίζεται να χρησιμοποιείται σε θερμοκρασίες περιβάλλοντος μεγέθους από 10 °C έως 32 °C';

Εύκρατη: 'η συγκεκριμένη συσκευή ψύξης προορίζεται να χρησιμοποιείται σε θερμοκρασίες περιβάλλοντος μεγέθους από 16 °C έως 32 °C';

Υποτροπική: 'η συγκεκριμένη συσκευή ψύξης προορίζεται να χρησιμοποιείται σε θερμοκρασίες περιβάλλοντος μεγέθους από 16 °C έως 38 °C';

Τροπική: 'η συγκεκριμένη συσκευή ψύξης προορίζεται να χρησιμοποιείται σε θερμοκρασίες περιβάλλοντος μεγέθους από 16 °C έως 43 °C';

Τα παραγγελθέντα μέρη στον παρακάτω πίνακα μπορούν να ληφθούν από την Inventor:

Παραγγελθέν μέρος	Προμηθευθέν από	Ελάχιστος χρόνος που απαιτείται για την προμήθεια
θερμοστάτες	Επαγγελματικό προσωπικό συντήρησης	Τουλάχιστον 7 έτη αφού το τελευταίο μοντέλο προβλήθηκε στην αγορά
αισθητήρες θερμοκρασίας	Επαγγελματικό προσωπικό συντήρησης	Τουλάχιστον 7 έτη αφού το τελευταίο μοντέλο προβλήθηκε στην αγορά
πλακέτες τυπωμένων κυκλωμάτων	Επαγγελματικό προσωπικό συντήρησης	Τουλάχιστον 7 έτη αφού το τελευταίο μοντέλο προβλήθηκε στην αγορά
πηγές φωτός	Επαγγελματικό προσωπικό συντήρησης	Τουλάχιστον 7 έτη αφού το τελευταίο μοντέλο προβλήθηκε στην αγορά
χειρολαβές πόρτας	Επαγγελματίες, επισκευαστές και τελικοί χρήστες	Τουλάχιστον 7 έτη αφού το τελευταίο μοντέλο προβλήθηκε στην αγορά
μεντεσέδες πόρτας	Επαγγελματίες, επισκευαστές και τελικοί χρήστες	Τουλάχιστον 7 έτη αφού το τελευταίο μοντέλο προβλήθηκε στην αγορά
δίσκοι	Επαγγελματίες, επισκευαστές και τελικοί χρήστες	Τουλάχιστον 7 έτη αφού το τελευταίο μοντέλο προβλήθηκε στην αγορά
καλάθια	Επαγγελματίες, επισκευαστές και τελικοί χρήστες	Τουλάχιστον 7 έτη αφού το τελευταίο μοντέλο προβλήθηκε στην αγορά
περιβλήματα πόρτας	Επαγγελματίες, επισκευαστές και τελικοί χρήστες	Τουλάχιστον 10 έτη αφού το τελευταίο μοντέλο προβλήθηκε στην αγορά

Υποβολή Εγγύησης

- Επισκεφθείτε τη σελίδα μας και ενεργοποιήστε την εγγύησή σας μέσω του παρακάτω link ή σκανάροντας το QR code

<https://www.inventoraircondition.gr/egiisi-inventor>



- Συμπληρώστε όλα τα πεδία όπως φαίνονται παρακάτω

Για να ενεργοποιήσετε την εγγύηση, παρακαλούμε συμπληρώστε τα παρακάτω πεδία

Στοιχεία ιδιοκτήτη	Στοιχεία μηχανήματος
Όνοματεπώνυμο*	Τύπος μηχανήματος*
Διεύθυνση*	Σειριακός αριθμός μηχανήματος*
Τ.Κ.*	Ημερομηνία αγοράς μηχανήματος*
Τηλέφωνο*	Αριθμός παραστατικού*
Διεύθυνση email*	Επιπλέον στοιχεία

Να εγγραφώ στο newsletter της Inventor

* Απαραίτητο πεδίο
Αποστέλοντας τη φόρμα εγγύησης αποδέχεστε τους όρους και τις προϋποθέσεις.

ΑΠΟΣΤΟΛΗ

- Μόλις ολοκληρωθεί η υποβολή της εγγύησης θα λάβετε την επιβεβαίωση κατοχύρωσης στο email σας

Cuprins

1.	Măsuri de siguranță	1
2.	Instalarea	3
2.1	Poziționarea	3
2.2	Distanțe necesare	3
2.3	Fixare.....	3
2.4	Curățarea frigiderului înainte de a fi folosit	3
2.5	Înainte de folosire	4
2.6	Accesoriile din interior	4
3.	Fotografia produsului	5
4.	Functionare	5
4.1	Pornirea	5
4.2	Zgomotele din interior	6
4.3	Instrucțiuni privind stocarea de alimente	6
4.4	Schimbarea lampei interioare	6
5.	Curățarea	6
5.1	Decongelarea	6
5.2	Curățarea la interior și exterior	6
5.3	Instrucțiuni suplimentare	7
6.	Mentenanța	7
6.1	Schimbarea lămpii interioare	7
6.2	Transportul produsului	7
6.3	Service	7
6.4	În caz de neutilizare	7
6.5	Instalarea și schimbarea stânga/dreapta a ușilor.....	7
7.	Verificari în caz de nefuncționare	10
7.1	De știut	10
8.	Economie de energie	11
9.	Reciclarea produsului	11

1. MĂSURI DE SIGRANȚĂ



Atenție: risc de incendiu / materiale inflamabile

Acest aparat este destinat utilizării în gospodării sau alte locuri similare cum ar fi bucătăriile magazinelor, birouri sau alte locuri de muncă; ferme, clienții hotelurilor, moteluri și alte medii de tip rezidențial; medii de tipul "bed and breakfast; catering și aplicații similare non-retail.

Dacă cablul de alimentare este deteriorat, acesta trebuie înlocuit de producător, de tehnicianul service sau de către o persoană calificată pentru a evita pericolele.

Nu stocați substanțe explozive cum ar fi recipientele ce conțin aerosoli, cu potențial inflamabil, în interiorul sau în apropierea acestui dispozitiv.

Aparatul trebuie să fie deconectat de la sursa de energie după utilizare și înainte de a efectua orice lucrare de întreținere.

ATENȚIE: Pastrati gurile de ventilație deschise, în interiorul carcasei aparatului sau în structura incorporată, fără obstrucții.

ATENȚIE: Nu utilizați alte aparate sau mijloace de a accelera procesul de dezghețare, altele decât cele recomandate de producător.

ATENȚIE: Nu deteriorați parcursul agentului frigorific al dispozitivului.

ATENȚIE: Nu folosiți aparate electrice în interiorul compartimentelor de stocare a alimentelor, altele decât cele recomandate de producător.

ATENȚIE: Va rugăm să aruncați frigiderul în conformitate cu reglementările locale deoarece conține gaze inflamabile și lichide de tip agent frigorific.

ATENȚIE: Când puneți în funcțiune aparatul, asigurați-vă că firul de alimentare nu este deteriorat în nici un fel.

ATENȚIE: Nu introduceți stecherul în prize multiple sau alte surse de alimentare în partea din spate a acestui aparat.

Nu utilizați prelungitoare ce nu au împământare.

PERICOL: Risc de blocare a copiilor. Înainte de a arunca vechiul frigider sau congelator:

- Scoateți ușile

- Nu scoateți sertarele deoarece există riscul de ranire a minorilor nesupravegheați

Frigiderul trebuie să fie deconectat de la sursa de curent înainte de a se instala accesoriile.

Agentul frigorific și spuma de ciclopentan sunt materiale inflamabile. Prin urmare, atunci când reciclați frigiderul acesta trebuie să fie ținut departe de orice sursă de incendiu și să fie reciclat de o companie specializată, pentru a preveni deteriorarea mediului înconjurător.

Pentru EN standard: Acest aparat poate fi folosit de copiii cu vârsta de minim 8 ani și de persoane cu handicap fizic sau mental, sau fără experiență sau cunoștințe dacă au primit acordul și instructajul cu privire la utilizarea aparatului într-un mod sigur, înțelegând pericolele implicate.

Copiii nu trebuie să interfereze cu aparatul. Curățarea și mentenanța nu trebuie să fie făcute de copii fără supraveghere. Copiii de la 3 la 8 ani au voie să încarce/descarce aparatele frigorifice.

Pentru IEC standard: Acest aparat nu trebuie să fie folosit de persoane (inclusiv copii) cu capacitate fizică, senzorială sau mentală redusă, sau lipsa de experiență sau cunoștințe, decât dacă au primit instrucțiuni din partea unei persoane calificată cu privire la utilizarea acestui aparat.

Copiii trebuie să fie supravegheați pentru a vă asigura că utilizează aparatul în mod corect.

PENTRU a evita contaminarea alimentelor, respectați vă rog instrucțiunile următoare:

– Deschiderea ușii pentru perioade lungi poate provoca o creștere semnificativă a temperaturii în compartimentele aparatului.

– Curățați cu regularitate suprafețele care pot intra în contact cu alimentele și sistemele de drenare accesibile.

– Curățați rezervoarele de apă dacă acestea nu au fost utilizate timp de 48 de ore; goliți sistemul de apă conectat la alimentarea cu apă, dacă apa nu a fost extrasă timp de 5 zile. (nota 1)

– Depozitați carnea crudă și peștele în recipiente adecvate în frigider, astfel încât să nu intre în contact cu sau să se scurgă pe alte alimente.

– Compartimente pentru alimente-congelate cu două-stele sunt potrivite pentru depozitarea mâncării pre-congelate, depozitarea, sau prepararea înghețatei și fabricarea cuburilor de gheață. (nota 2)

– Compartimentele cu una-, două- și trei-stele nu sunt potrivite pentru înghețarea alimentelor proaspete. (nota 3)

– Dacă aparatul frigorific este lăsat gol timp îndelungat, opriți, dezghețați, curățați, uscați și lăsați ușa deschisă pentru a împiedica dezvoltarea mucegaiului în interiorul aparatului.

– Pentru aparatele fără compartiment cu 4 -stele: acest aparat frigorific nu este potrivit pentru congelarea produselor alimentare. (nota 4)

Notă 1,2,3,4: Vă rugăm să confirmați dacă este aplicabil în funcție de tipul compartimentului produsului dvs..

PENTRU un aparat independent: acest aparat frigorific nu este destinat să fie utilizat ca-aparat încorporat.

Este necesar, pentru uși sau capace dotate cu încuietori și chei, ca cheile să nu fie la îndemâna copiilor și în vecinătatea aparatului frigorific, pentru a preveni blocarea copiilor în interior.

ORICE înlocuire sau întreținere a lămpilor cu LED este destinată a fi făcută de producător, agentul său de service sau de către o persoană cu o calificare similară.

2. INSTALARE

2.1 Poziționarea

Asigurați-vă că locul ales pentru poziționarea frigiderului este pe o podea plată și fermă, și camera bine ventilată cu temperatura medie a camerei între 16 °C și 43 °C. Evitați instalarea frigiderului lângă o sursă de căldură, cum ar fi aragazul, boilerul sau radiatorul. Evitați ca frigiderul să fie așezat în lumina directă a soarelui, deoarece crește consumul de energie electrică. Temperaturile ambientale reci extreme pot face ca frigiderul să nu funcționeze în mod corespunzător. Acest aparat nu este conceput pentru utilizarea într-un garaj sau în aer liber. Nu acoperiți frigiderul cu nici un fel de material.

La instalarea aparatului, asigurați-vă că ați lăsat 10 cm de spațiu liber în ambele părți laterale, 10 cm în spate și 30 cm în partea superioară a frigiderului. Acest lucru va permite aerului rece să circule în jurul aparatului îmbunătățind eficiența procesului de răcire.

2.2 Cerințe de spațiu pentru uși

Ușa aparatului trebuie să se poată deschide complet, așa cum se arată în figură.

$W \times D \geq 1180 \times 1150 \text{ mm}$

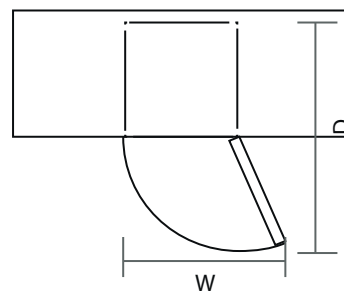

2.3 Așezarea la nivel a frigiderului

Pentru a face acest lucru reglați cele două picioare de nivelare din partea din față a frigiderului.

În cazul în care unitatea nu este la nivel, ușa și aliniamentele de etanșare magnetică nu vor fi acoperite în mod corespunzător.

Înainte de utilizare asigurați-vă că piciorul frigiderului atinge solul.

Rotiți în direcția dorită astfel încât frigiderul să stea ferm și fără să se balanseze.

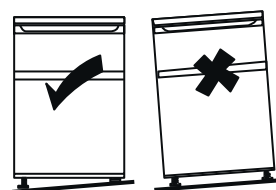

2.4 Curățarea frigiderului înainte de a fi folosit

Ștergeți interiorul unității cu o soluție slabă de apă cu bicarbonat. Apoi se clătește cu apă caldă cu un burete stors sau pânză. Spălați rafturile și cutia de legume-fructe în apă caldă cu săpun și apoi lăsați la uscat înainte de a le pune în frigider. Curățați exteriorul aparatului cu o cârpă umedă. Dacă aveți nevoie de mai multe informații consultați secțiunea de curățare.

2.5 Înainte de utilizare

Nu deteriorați cablul de alimentare sub nicio formă, astfel încât să se asigure utilizarea în siguranță, nu utilizați frigiderul când cablul de alimentare este deteriorat sau ștecherul este defect.

Nu puneți obiecte inflamabile, explozive, volatile și extrem de corozive în frigider, pentru a preveni producerea de daune produse de incendiu sau accidente.

Nu așezați obiecte inflamabile lângă frigider pentru a evita incendiile.

Acest produs este frigider este destinat uzului casnic și este adecvat exclusiv pentru depozitarea alimentelor.

În conformitate cu standardele naționale, frigiderul de uz casnic nu se utilizează pentru alte scopuri, cum ar fi stocarea de sânge, medicamente sau produse biologice. Nu așezați obiecte precum cutiile metalice de bauturi în congelator pentru a preveni explozia acestora și eventuale răniri sau daune.

Înainte de a introduce orice mâncare în frigider, porniți-l și așteptați 24 de ore, pentru a vă asigura că frigiderul funcționează corespunzător și pentru a permite timp pentru a ajunge la temperatura corectă. Frigiderul nu ar trebui să fie supraîncărcat



- Înainte de a conecta
Trebuie să verificați dacă priza este compatibilă cu ștecherul frigiderului.
- Înainte de a porni frigiderul!
Nu porniți frigiderul mai devreme de două ore după mutarea aparatului.

2.6 Accesorii de interior

Diverse rafturi de depozitare din sticlă sau plastic sunt incluse – combinațiile diferă în funcție de modelele frigiderului.

Întotdeauna puneți unul dintre rafturile de depozitare din sticlă în mărime completă deasupra containerului de fructe și legume, și păstrați-l în această poziție. Pentru a face aceasta, trage-ți de raftul de depozitare înainte până când poate fi rabatat în sus sau în jos și îndepărtat.

Vă rugăm să faceți același lucru în sens invers pentru a introduce pe raft la o înălțime diferită.



În scopul de a profita din plin de volumul compartimentului de depozitare a alimentelor proaspete și de compartimentul de păstrare a alimentelor congelate, utilizatorul poate elimina una sau mai multe rafturi, sertare, din interiorul aparatului, conform cu utilizarea de zi cu zi.

3. PREZENTARE PRODUS

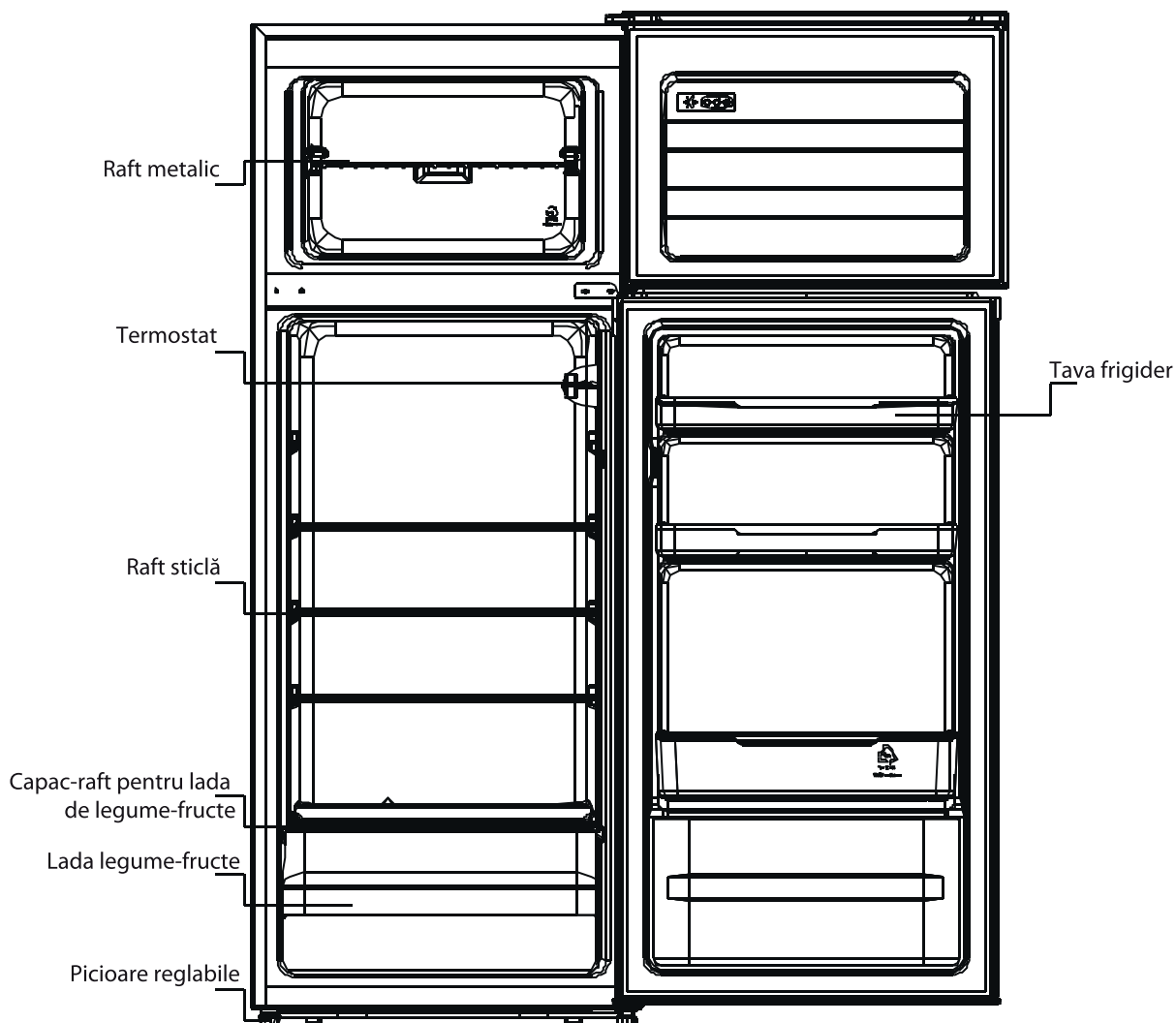

*Toate imaginile din acest manual de instrucțiuni sunt numai pentru referință; vă rugăm să consultați frigiderul pentru detalii exacte cu privire la accesoriile complete.

4. FUNCȚIONARE

4.1 Pornirea frigiderului

Butonul de selectare a temperaturii este situat pe partea dreaptă a peretelui interior al frigiderului

Setarea "Off": Oprit

Setarea "Min": Minim (mai puțin rece)

Setarea "Med": Funcționare normală (adecvat pentru majoritatea situațiilor)

Setarea "Max": Maxim (cel mai rece)

În timpul temperaturi ridicate aplicații ambientale (în zilele fierbinți de vară), este recomandat să se stabilească pentru termostat cea mai mare temperatură (poziția "Max"). Această situație poate cauza funcționarea continuă a compresorului pentru a putea menține o temperatură scăzută în cabinet.

Pentru prima dată când porniți frigiderul, setați butonul termostatului la "Med". Da-ți un timp frigiderului să se răcească complet înainte de a adăuga alimente. Cel mai bun timp de așteptare este de 24 de ore înainte de adăugarea de alimente. Butonul termostatului controlează temperatura. Când butonul de control al termostatului este setat pe OFF, frigiderul nu va funcționa.

4.2 Zgomot în interiorul aparatului!

Puteți auzi unele zgomote neobișnuite. Cea mai mare parte a acestora sunt perfect normale, dar ar trebui să știți de ele!

Aceste zgomote sunt cauzate de circulația lichidului în sistem refrigerent de răcire. Au devenit mai pronunțate de la introducerea gazelor libere CFC. Aceasta nu este o defecțiune și nu va afecta performanța unității dumneavoastră. Acestea indică faptul că motorul compresorului funcționează, agentul frigorific fiind transportat prin sistemul frigiderului.

4.3 Sfaturi pentru păstrarea alimentelor în Unitatea

- Produsele gătite din carne/pește trebuie să fie stocate mai sus fata de carnea/peștele proaspete, pentru a evita transferul de bacterii. Păstrați carnea / peștele într-un recipient suficient de mare pentru a colecta zeama și acoperit în mod corespunzător. Vasul se pune pe raftul cel mai de jos.
- Lăsați spațiu în jurul alimentelor, pentru a permite aerului să circule în interior. Asigurați-vă că toate părțile frigiderului se păstrează rece.
- Pentru a preveni transferul de arome și uscarea alimentelor, ambalați sau acoperiți mâncarea separat. Fructele și legumele nu trebuie să fie înfășurate sau ambalate.
- Întotdeauna lăsați alimente pregătite să se răcească înainte de a le pune la frigider. Acest lucru va ajuta la menținerea temperaturii interne a frigiderului.
- Pentru a prevenii pierderea aerului rece să iasă din frigider, încercați să limitați numărul de deschideri ale ușii. Vă recomandăm să deschideți ușa frigiderului doar atunci când aveți nevoie să puneți sau să scoateți produse alimentare.

4.4 Schimbarea becului

Înlocuirea lămpii se va efectua de personal calificat.

5. CURĂȚAREA

5.1 Dezghețarea

Dezghețarea se efectuează automat pentru frigiderele Frost-free.

5.2 Curățarea frigiderului la interior și exterior

- Scoateți toate rafturile și coșul de salată. Pentru a elimina coșul de salată scoateți în primul scoateți raftul-capac de deasupra lui.
- Ștergeți interiorul cu o soluție slabă de apă cu bicarbonat și apoi clătiți cu apă caldă folosind un burete stors u cârpă. Ștergeți cu o cârpă uscată și după ce se usucă complet puneți rafturile și lada de fructe în interior.
- Folosiți o cârpă umedă pentru a curăța exteriorul, și apoi ștergeți cu un lac de mobilier standard. Ușa frigiderului se va tine închisă pentru a evita ruperea garniturii magnetice a ușii sau din interiorul frigiderului.
- Grila din spatele frigiderului și componentele adiacente pot fi aspirate cu un aspirator folosind capul cu perie moale.

5.3 Sfaturi privind curățarea

Condensarea poate să apară pe exteriorul unității. Aceasta se poate datora unei schimbări de temperatură din camera. Ștergeți orice reziduu de umiditate. În cazul în care problema-continuă, vă rugăm să contactați un tehnician calificat pentru asistență.

6. ÎNTREȚINEREA

6.1 Schimbarea becului interior

Înlocuirea becului interior se va efectua de către persoane calificate.

6.2 Manipulare / Mutarea frigiderului

Țineți frigiderul de părțile laterale sau de bază în timpul manipulării. În niciun caz nu ar trebui să fie ridicat prin ținerea de marginile suprafeței de sus.

6.3 Reparare

Frigiderul trebuie reparat de către personal calificat și numai cu piese originale. În nici un caz nu trebuie să încercați să reparați singuri frigiderul. Reparațiile efectuate de persoane fără experiență pot cauza leziuni sau defecțiuni grave. Contactați un tehnician calificat și autorizat.

6.4 Neutilizarea frigiderului pentru perioade lungi de timp

Atunci când frigiderul nu este folosit pentru o perioadă lungă de timp, deconectați-l de la rețeaua de alimentare, scoateți toate produsele alimentare și curățați aparatul, apoi lăsați ușa deschisă pentru a preveni producerea mirosurilor neplăcute.

6.5 Instalarea și schimbarea stânga/dreapta a ușii

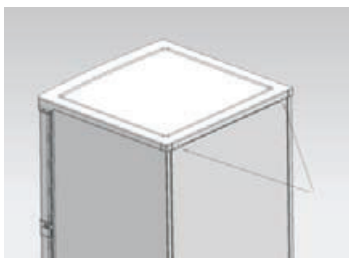

1. Scoateți cele două capace și înlăturați capacul superior.

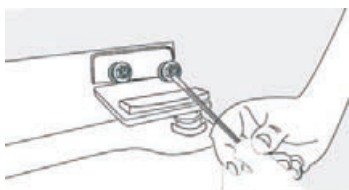

2. Scoateți cele 2 șuruburi fixate pe balama

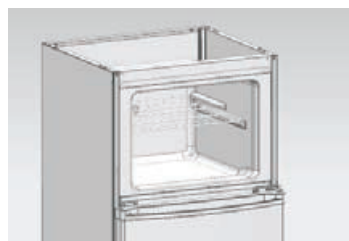

3. Scoateți ușa



4. Deșurubați balamaua fixă, scoateți ușa.

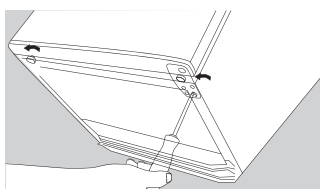

5. Desfaceți șuruburile și scoateți suportul balamalei din bază. O cheie poate fi necesară pentru a slăbi șuruburile. Scoateți balama și re-poziționați-o în locația pe partea opusă

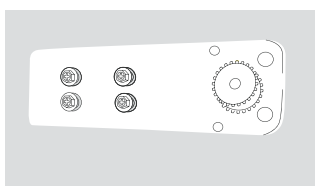

Scoateți șuruburile și piciorul reglabil din partea opusă și fixați-le înapoi unde au fost pe suportul balamalei.

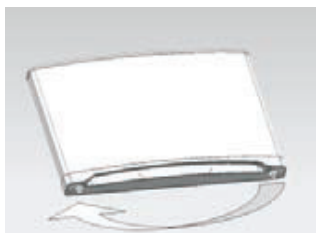

6. Va veni sub prag, o schimbare de la o parte în cealaltă parte.

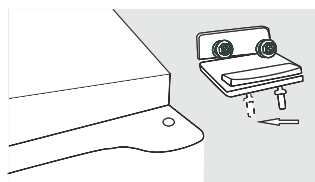

7. Desfaceți șurubul de la gaura dreaptă sus și fixați-l la gaura din stânga, așa cum este indicat de săgeată

8. Manșonul ușii va fi de pe partea inițială pe partea cealaltă

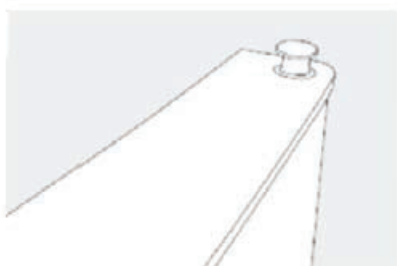

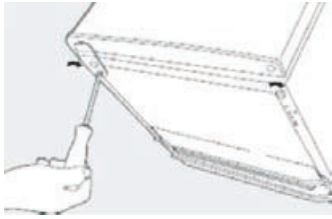

9. Instalați balamaua în partea de jos, strângând șuruburile



10. Instalați balamaua și fixați cu șuruburi.

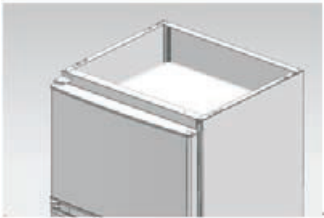

11. Instalați ușa și balamaua cu șuruburi.

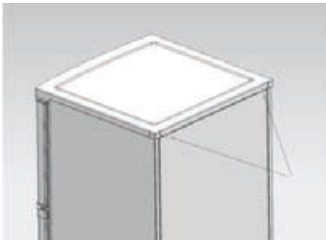

12. Instalați capacul.

7. Probleme în funcționare

Atunci când frigiderul nu este folosit pentru o perioadă lungă de timp, deconectați-l de la rețeaua de alimentare, scoateți toate produsele alimentare și curățați aparatul, apoi lăsați ușa deschisă pentru a preveni producerea mirosurilor neplăcute.

Nu funcționează	Verificați dacă ștecherul frigiderului este conectat la priză; Tensiunea este scăzută;
Miros neplăcut	Curentul este oprit sau circuitul este întrerupt. Alimentele cu miros trebuie sigilate sau acoperite Pot fi alimente alterate în frigider
Compresorul funcționează pe perioade lungi de timp	Interiorul ar trebui curățat Este normală funcționarea compresorului pe perioade lungi în timpul verilor când temperatura ambientală este ridicată Nu puneți în congelator prea multe produse în același timp Nu puneți alimente fierbinți
Lumina interioară nu funcționează	Deschiderea frecventă a ușii frigiderului Frigiderul nu este conectat la priză
Ușa frigiderului nu se închide corespunzător	Becul interior este ars sau defect Ușa congelatorului este blocată de produsele din interior Prea multe produse în frigider
Zgomote puternice	Frigiderul este înclinat Posibil ca alimentele să nu fie bine aranjate sau frigiderul să nu fie la nivel Posibil ca accesoriile interioare să nu fie bine puse

7.1 Sfaturi utile:

- Frigiderul poate emite căldură care se încadrează în special în funcționarea pe timpul verii, acest lucru este cauzat de radiația condensatorului, iar acesta este un fenomen normal.
- Condensarea: fenomenul de condensare va fi detectat pe suprafața exterioară și sigiliile ușii congelatorului atunci când umiditatea mediului ambiant este mare, acest lucru este un fenomen normal, iar condensarea poate fi ștearsă cu un prosop uscat.
- Zgomot ciudat: este generat prin rularea compresorului în special la pornirea sau oprirea frigiderului.

8. SFATURI PENTRU ECONOMISIREA ENERGIEI

Încercați pe cât posibil să nu deschideți ușa de prea multe ori, mai ales atunci când vremea este umedă și caldă. După ce ați deschis ușa, închideți cât mai repede posibil. Verificați periodic dacă frigiderul este ventilat suficient (circulație adecvată a aerului în spatele aparatului).

În condiții normale de temperatură, vă rugăm să setați termostatul în poziția de mijloc. Înainte de a încărca frigiderul cu alimente proaspete, asigurați-vă că acestea sunt răcite la temperatura camerei.

Gheața și stratul de îngheț cresc consumul de energie, deci curățați frigiderul de îndată ce stratul este 3-5 mm grosime.

Dacă aparatul este prevăzut cu condensatorul la exterior, peretele din spate trebuie să fie mereu curat, fără praf sau alte impurități.

- Aparatul trebuie să fie situat în cea mai răcoroasă zonă a camerei, departe de căldura produsă de alte aparate electrocasnice sau încălzitoare electrice sau de alt tip, precum și departe de lumina directă a soarelui.
- Lăsați alimentele fierbinți să se răcească la temperatura camerei înainte de a le pune în frigider. Supraîncărcarea frigiderului forțează compresorul pentru a rula mai mult. Alimentele ce se congelează prea încet pot pierde din calitate sau se pot strica.
- Asigurați-vă că alimentele au fost ambalate în mod corespunzător, și ștergeți recipientele înainte de a le introduce în aparat. Acestea trebuie să fie uscate. Acest lucru poate duce la apariția gheții interiorul aparatului.
- Recipientele pentru alimente nu trebuie să fie căptușite cu folie de aluminiu, hârtie de ceară, sau hârtie creponată. Aceste materiale interferă cu circulația aerului rece, ceea ce face aparatul mai puțin eficient.
- Organizați și etichetați alimentele pentru a reduce timpul pentru căutări în interiorul frigiderului, astfel încât ușa frigiderului să nu fie ținută deschisă un timp lung de timp. Scoateți din frigider mai multe din cele de care aveți nevoie printr-o singură deschidere a ușii, iar apoi închideți cât mai repede posibil.

9. Reciclarea

Aparatele vechi au o anumită valoare reziduală. O metodă ecologică de eliminare va asigura materii prime valoroase ce pot fi recuperate și utilizate din nou. Agentul frigorific folosit și materialul izolant necesită proceduri speciale de eliminare. Asigurați-vă că nici una din conductele din partea din spate a aparatului nu sunt deteriorate înainte de eliminare. În ceea ce privește opțiunile de eliminare a aparatului vechi și ambalajele de la unul nou pot fi obținute la nivel local.

Ca măsură de siguranță, atunci când aruncați frigiderul demontați ușile și balamalele.

Reciclarea corectă a acestui produs	
	<p>Reciclarea corectă a acestui produs</p> <p>Acest marcaj indică faptul că acest produs nu trebuie aruncat împreună cu alte deșeuri de uz casnic pe întreg teritoriul UE. Pentru a preveni posibile efecte dăunătoare asupra mediului sau sănătății umane de la aruncarea necontrolată a deșeurilor, reciclați în mod responsabil pentru a promova re folosirea resurse de materiale. Pentru a returna produsul utilizat, vă rugăm să folosiți sistemul de colectare sau contactați magazinul de unde a fost achiziționat produsul. Ei pot lua acest produs pentru reciclare în condiții de siguranță a mediului.</p>

Pentru mai multe informații, vă rugăm să contactați autoritățile locale sau distribuitorul de unde ați achiziționat produsul.

Table 1 Climate classes

Class	Symbol	Ambient temperature range °C
Extended temperate	SN	+ 10 to + 32
Temperate	N	+ 16 to + 32
Subtropical	ST	+ 16 to + 38
Tropical	T	+ 16 to + 43

Interval de temperatură extins: 'Acest aparat frigorific este destinat să fie utilizat la temperaturi ambientale cuprinse între 10 ° C și 32 °C';

Temperat: 'Acest aparat frigorific este destinat să fie utilizat la temperaturi ambientale cuprinse între 16 °C și 32 °C';

Subtropical: 'Acest aparat frigorific este destinat să fie utilizat la temperaturi ambientale cuprinse între 16 °C și 38 °C';

Tropical: 'Acest aparat frigorific este destinat să fie utilizat la temperaturi ambientale cuprinse între 16 °C și 43 °C'.

Piesele comandate din tabelul următor pot fi achiziționate de pe canalul INVENTOR:

Piesă Comandată	Furnizat de	Timp Minim Necesar Pentru Furnizare
termostate	Personal profesional de întreținere	Cel puțin 7 ani de la lansarea ultimului model pe piață
senzori de temperatura	Personal profesional de întreținere	Cel puțin 7 ani de la lansarea ultimului model pe piață
plăci de circuite imprimate	Personal profesional de întreținere	PCel puțin 7 ani de la lansarea ultimului model pe piață
surse de lumină	Personal profesional de întreținere	Cel puțin 7 ani de la lansarea ultimului model pe piață
mânere uși	Reparatori profesioniști și utilizatori finali	Cel puțin 7 ani de la lansarea ultimului model pe piață
balamale de ușă	Reparatori profesioniști și utilizatori finali	Cel puțin 7 ani de la lansarea ultimului model pe piață
tăvi	Reparatori profesioniști și utilizatori finali	Cel puțin 7 ani de la lansarea ultimului model pe piață
coșuri	Reparatori profesioniști și utilizatori finali	Cel puțin 7 ani de la lansarea ultimului model pe piață
garnituri uși	Reparatori profesioniști și utilizatori finali	Cel puțin 10 ani de la lansarea ultimului model pe piață

Activati-va garantia

- Accesati link-ul de mai jos sau scanati codul QR pentru a va activa garantia pe site-ul nostru.

<https://www.inventoraerconditionat.ro/certificatul-de-garantie-inventor-aer-conditionat-si-electrocasnice>



- Completati toate campurile conform exemplului de mai jos

Pentru a activa garantia, va rugam sa completati urmatoarele campuri

Detalii proprietar	Detalii unitate
Nume complet* <input type="text"/>	Tip aparat* <input type="text"/>
Adresa* <input type="text"/>	Numarul de Serie al aparatului* <input type="text"/>
Cod Postal* <input type="text"/>	Data de achizitie* <input type="text"/>
Numar de telefon* <input type="text"/>	Numar Factura* <input type="text"/>
E-mail* <input type="text"/>	Detalii aditionale <input type="text"/>

Abonati-va la Newsletter-ul Inventor

* Camp obligatoriu
Cu acest certificat de garantie acceptati Termenii si Conditile.

TRIMITE

- Odata ce garantia a fost activata, veti primi un email de confirmare



REFRIGERATOR

DOUBLE DOOR



Scan here to download the latest version of this manual.
Σαρώστε εδώ για να κατεβάσετε την τελευταία έκδοση του εγχειριδίου.





REFRIGERATOR DOUBLE DOOR

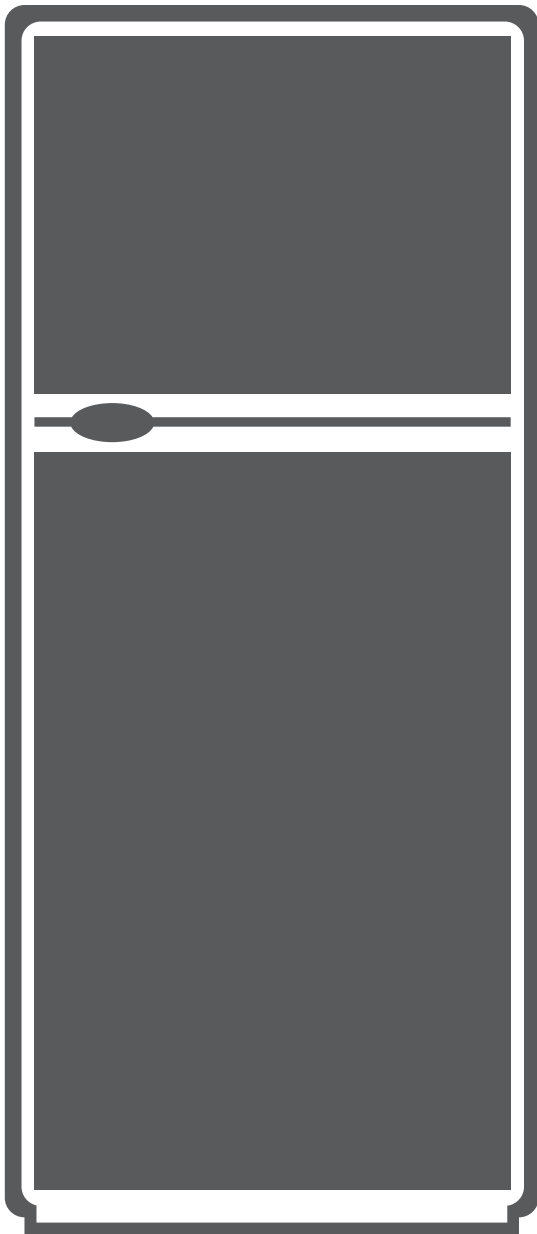

- **PRODUCT FICHE MANUAL**
- **ΕΓΧΕΙΡΙΔΙΟ PRODUCT FICHE**
- **MANUAL PRODUCT FICHE**

MODELS:

DP1446S

DP1444IN

DP1440W



Contents

English.....	4
Ελληνικά	5
Romanian	6

PRODUCT FICHE

NAME OR TRADEMARK: INVENTOR

DOUBLE DOOR

Model		DP1440W	DP1446S	DP1444IN
Color		White	Silver	Inox
Climate Class		ST/N	ST/N	ST/N
Energy Efficiency Class		F	E	E
Energy Consumption	[kwh/24h]/ [KWh/y]	0.605/221	0.482/176	0.482/176
Power Supply	V/Ph	220-240/50	220-240/50	220-240/50
Protection Against Electric Shock		I	I	I
Insulation		Cyclopentane	Cyclopentane	Cyclopentane
Total Gross Volume	(L)			
Total Net Volume	(L)	204	204	204
Freezer Net Volume	(L)	41	41	41
Refrigerator Net Volume	(L)	163	163	163
Freezer Defrosting Type		Static	Static	Static
Refrigerator Defrosting Type		Static	Static	Static
Control System		Mechanic	Mechanic	Mechanic
Refrigerant	Type/g	R600a,45	R600a,45	R600a,45
Cooling Capacity	kg/24h	2	2	2
Temperature Rise Time	h	8	8	8
Noise level	[dB(A)]	40	40	40
Refrigerator Lamp Rated Power	(W)	2	2	2
Freezer Lamp Rated Power	(W)	-	-	-
Reversible door		Yes	Yes	Yes
Product Dimensions (WxDxH)	mm	550x550x1.430	550x550x1.430	550x550x1.430
Packing Dimensions (WxDxH)	mm	585x585x1.462	585x585x1.462	585x585x1.462
Net Weight	kg	35	38.0	38.0
Gross weight	kg	39	43.0	43.0
Freezer				
Crisper		-	-	-
Shelves		1	1	1
Door Shelf Basket		-	-	-
Refrigerator				
Shelves		3	3	3
Crisper		1	1	1
Door Shelf Basket		3	3	3

PRODUCT FICHE

ΕΜΠΟΡΙΚΟ ΣΗΜΑ: INVENTOR

DOUBLE DOOR

Μοντέλο		DP1440W	DP1446S	DP1444IN
Χρώμα		Λευκό	Silver	Inox
Κλιματική Κλάση		ST/N	ST/N	ST/N
Ενεργειακή Κλάση		F	E	E
Κατανάλωση	[kwh/24h]/ [KWh/y]	0.605/221	0.482/176	0.482/176
Τροφοδοσία Ρεύματος	V/Ph	220-240/50	220-240/50	220-240/50
Προστασία από Ηλεκτροπληξία		I	I	I
Μόνωση		Cyclopentane	Cyclopentane	Cyclopentane
Συνολική Μεικτή Χωρητικότητα	(L)			
Συνολική Καθαρή Χωρητικότητα	(L)	204	204	204
Καθαρή Χωρητικότητα Κατάψυξης	(L)	41	41	41
Καθαρή Χωρητικότητα Συντήρησης	(L)	163	163	163
Τύπος Απόψυξης Κατάψυξης		Στατικός	Στατικός	Στατικός
Τύπος Απόψυξης Συντήρησης		Στατικός	Στατικός	Στατικός
Έλεγχος Θερμοκρασίας		Μηχανικός	Μηχανικός	Μηχανικός
Ψυκτικό Υγρό	Τύπος/g	R600a,45	R600a,45	R600a,45
Ψυκτική Απόδοση	kg/24h	2	2	2
Χρόνος Ανόδου Θερμοκρασίας	h	8	8	8
Στάθμη Θορύβου	[dB(A)]	40	40	40
Ισχύς Λυχνίας στη Συντήρηση	(W)	2	2	2
Ισχύς Λυχνίας στη Κατάψυξη	(W)	-	-	-
Αναστροφή Πόρτας		Ναι	Ναι	Ναι
Διαστάσεις Προϊόντος (ΜxΒxΥ)	mm	550x550x1.430	550x550x1.430	550x550x1.430
Διαστάσεις Συσκευασίας (ΜxΒxΥ)	mm	585x585x1.462	585x585x1.462	585x585x1.462
Καθαρό Βάρος	kg	35	38.0	38.0
Μεικτό Βάρος	kg	39	43.0	43.0
Τμήμα Κατάψυξης				
Συρτάρια		-	-	-
Ράφια		1	1	1
Θήκες Πόρτας		-	-	-
Τμήμα Συντήρησης				
Ράφια		3	3	3
Συρτάρια		1	1	1
Θήκες Πόρτας		3	3	3

PRODUCT FICHE

MARCA: INVENTOR

DOUBLE DOOR

Model		DP1440W	DP1446S	DP1444IN
Culoare		Alb	Argintiu	Inox
Clasa Climaterica		ST/N	ST/N	ST/N
Clasa Energetica		^{21.} F	E	E
Consum	[kwh/24h]/ [KWh/y]	0.605/221	0.482/176	0.482/176
Tensiune de Alimentare	V/Ph	220-240/50	220-240/50	220-240/50
Sistem de Protectie impotriva Socurilor Electrice		I	I	I
Izolatie		Cyclopentane	Cyclopentane	Cyclopentane
Volum Brut	(L)			
Volum Net	(L)	204	204	204
Volum Net Congelator	(L)	41	41	41
Volum Net Frigider	(L)	163	163	163
Tip Decongelare Congelator		Static	Static	Static
Tip Decongelare Frigider		Static	Static	Static
Sistem de Control		Mecanic	Mechanic	Mecanic
Agent Frigorific	Type/g	R600a,45	R600a,45	R600a,45
Capacitate Racire	kg/24h	2	2	2
Perioada de Crestere a Temperaturii	h	8	8	8
Nivel Zgomot	[dB(A)]	40	40	40
Putere bec Frigider	(W)	2	2	2
Putere bec Congelator	(W)	-	-	-
Usa Reversibila		Da	Da	Da
Dimensiuni (LxAxH)	mm	550x550x1.430	550x550x1.430	550x550x1.430
Dimensiunile Ambalajului (LxAxH)	mm	585x585x1.462	585x585x1.462	585x585x1.462
Greutate Neta	kg	35	38.0	38.0
Greutate Bruta	kg	39	43.0	43.0
Congelator				
Sertar		-	-	-
Rafturi		1	1	1
Rafturi pe Usi		-	-	-
Frigider				
Rafturi		3	3	3
Sertar		1	1	1
Rafturi pe usi		3	3	3

NOTES

A series of horizontal dotted lines for writing notes.



REFRIGERATOR

DOUBLE DOOR



Scan here to download the latest version of this manual.
Σαρώστε εδώ για να κατεβάσετε την τελευταία έκδοση του εγχειριδίου.



Importer/Manufacturer: INVENTOR A.G. S.A.

24th km National Road Athens - Lamia & 2 Thoukididou Str., Ag. Stefanos, 145 65,
Tel.: +30 211 300 3300, Fax: +30 211 300 3333